



VIGI

Product Guide

VIGI Surveillance Solution

Reliably Smart
www.tp-link.com

2 0 2 3





CORPORATE PROFILE

TP-Link serves as the network backbone for homes and businesses worldwide. With humble beginnings in 1996, the company has grown to what it is today: a global leader.

You can find our Reliably Smart devices connecting 1.7 billion people in over 170 countries and regions. These numbers have led analyst firm IDC to rank us as the No. 1 provider of Wi-Fi devices for over a decade.*

We understand the importance of the always-connected lifestyle. Our products feature the latest technologies and are engineered to last. The TP-Link portfolio includes home-business-ISP networking, surveillance, and consumer electronics. Rest assured that you're receiving our proven stability, performance, and value with every device.

As our lives grow ever more connected, TP-Link will continue to pursue excellence and explore the possibilities of tomorrow.

About VIGI

The VIGI professional surveillance system by TP-Link is dedicated to protecting the business that you've worked hard to build—whenever, wherever. Intelligent functions, reliable quality guarantees, and world-class support work together in our one-stop solutions to ensure your business is safe and sound.

VIGI stands on the shoulders of TP-Link and is always moving forward. Based on TP-Link's rich experience in the surveillance market and professional business solutions, VIGI is committed to providing continuous, structured vigilance for you and your business with innovations and reliability.

*According to the latest published IDC Worldwide Quarterly WLAN Tracker Report, Q2, 2022 Final Release.

CONTENTS

VIGI Surveillance Solutions	01
Retail	03
Education	07
Hospitality	11
Network Camera	15
Network Video Recorder	23
Network Video Decoder	25
Solar Panel System	26
Management System	27
VMS	28
VMS Workstation	29
Cloud VMS	30
VIGI App	31
Cloud Services	32

VIGI Surveillance Solutions

Professional and Efficient One-Stop Solution

TP-Link offers a one-stop solution in accordance with our 'FARE' principle—Functional, Advanced, Reliable, Easy.



Comprehensive Product Categories

VIGI offers various kinds of surveillance products for multiple situations, including different types of network cameras, network video recorders, decoders and VMS Workstation, and more.



Professional Management Platforms

Control your business with greater flexibility and ease-of-use with VIGI's comprehensive management platforms.



Lightweight Management

Web UI / NVR GUI / VIGI App
VIGI Security Manager



Integrated Management

IP-Based Local VMS
VMS Workstation

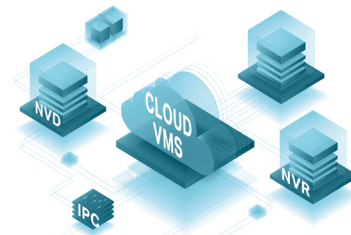

Highly Scalable Management

Cloud VMS

Reliable Qualities

Continuous Innovations
Independent research and development allow TP-Link to master the core technology and react rapidly to changes in the market.

Vertical Integration
One of the few wireless networking companies that operate in-house manufacturing facilities to maintain the standard of every component.

High-Level Manufacturing
Decades of experience and the combination of supporting facilities ensure complete quality control.

Complete Quality Control
TP-Link develops, builds, crafts, and sells products from start to finish with rigorous tests and whole-process quality control.

Wide Range of Application Scenarios

Flexible Deployment with Multiple Methods

Wi-Fi and 4G are additional methods for certain VIGI cameras to connect to networks, which helps VIGI cameras easily connect to the internet and extend to more application scenarios.

PoE and solar panel systems make your wiring remarkably easy and convenient, so that VIGI cameras can be deployed more flexibly.

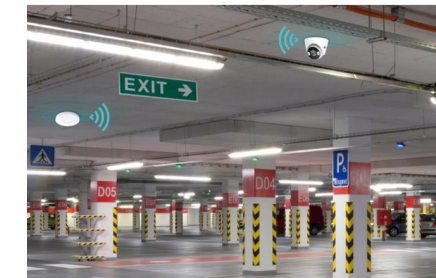

ONVIF for Third-Party Compatibility

The VIGI system can easily cooperate with third parties to build up and extend your surveillance network with ONVIF.

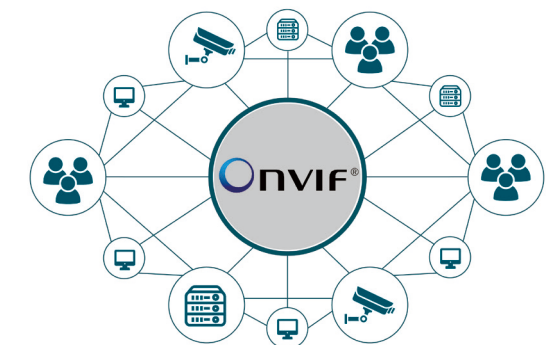

Excellent Pre- and After-Sales Services

VIGI provides not only products with outstanding quality but also whole service for complete client satisfaction.

After-Sales Services

- Global Call Center Providing HotlineSupport
- 24/7 Post-Sales Email Service
- Online SMB Community

Quality of Service

- Replacement and Warranty
- Constant Firmware Updates from the Cloud

Partner Program

<https://partner.tp-link.com/>

VIGI values its relationship and commitment to its partners. For Value-added Resellers (VARs) and System Integrators (SIs) looking for access to even better deals and tailored support, VIGI has designed the Partner Program to reward loyalty and help grow business.

User Community

<https://community.tp-link.com/en/business/>

Technical support and case sharing.
Your direct dialogue with VIGI.
When it comes to your business, we know you want to learn more...



Forums



Stories



Knowledge Base

Retail

Shopping Malls | Supermarkets | Department Stores | Shops | and More



Challenges

Due to the impact of online stores, traditional physical shops are facing more competition in improving profitability and retrieving customers. Meanwhile, potential thefts and scams lead to extra property loss.

Complex Security Challenges

- Intruders
- Shoplifting

Difficult Shop Administration

- Slack staff/Internal theft
- Improperly placed goods

Insufficient Sales & Profits

- Non User-based Sales Strategies
- Incomplete Market Feedback

Solution Overview

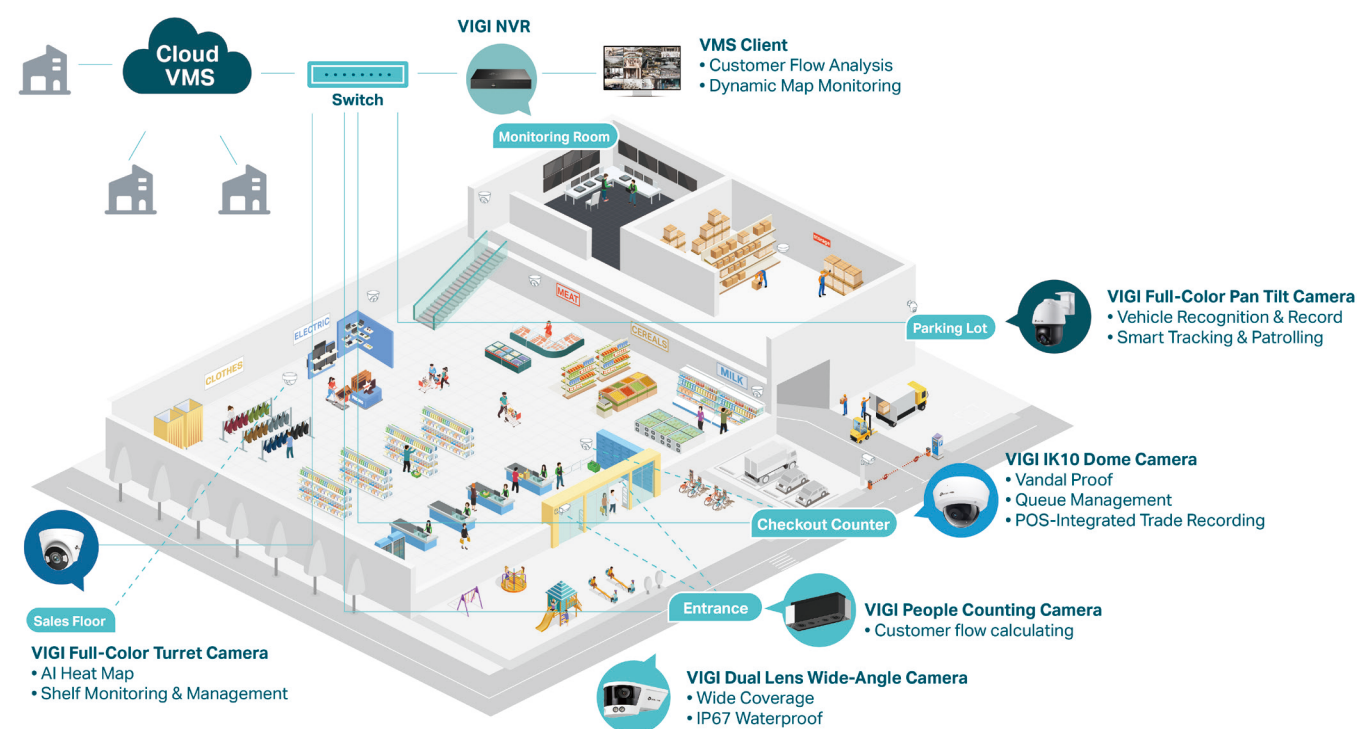

Highlights

Loss Prevention

Have everything under control with the VIGI AI defense system. Receive notifications as soon as an abnormality is detected and actively defend your property with VIGI cameras.

Intelligent Event Detection

Accurate event detection based on AI features target intrusion and suspicious acts near shelves, checkout counter, and storage.



- Motion Detection
- Queue Detection*
- Departure Monitoring*
- Abundant Object Detection
- Smoke Detection*
- Area Intrusion
- Abnormal Voice Detection*
- Motion Detection
- Line-Crossing
- Loitering Detection*
- Illegal Parking Detection*
- Camera Tampering



Active Defense

Scare off intruders and leave nowhere to hide with sound and light alarm. High-resolution cameras automatically record the event as further evidence.

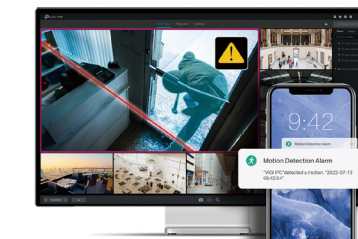

Customized Notifications (Local & Remote)

Know what happens in your shop instantly with notifications and remote monitoring. Take action when needed.

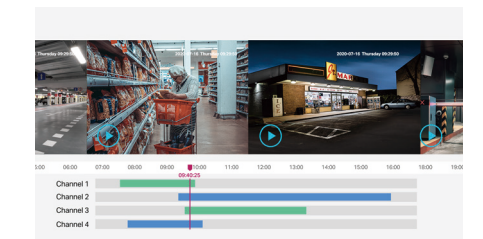

Reliable Evidence Storage and Lookback

Easily filter out video clips of events and store them locally or via cloud. Quickly look back and export the clips when needed.

Improve Services

Inform and arrange your clerks when needed to improve shopping experiences, such as a quick checkout with less waiting, and a tidy assortment of goods on the shelves.

Queue Management*

Inform you manager when necessary to open another checkout counter to shorten customer waiting time.

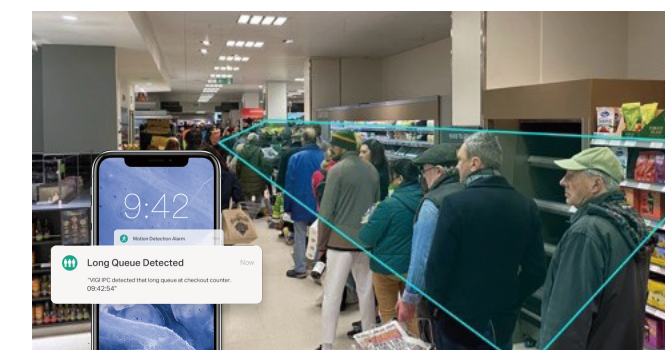

Shelf Monitoring*

Reminds you to rearrange the shelf or replenish goods when there are goods misplaced, out-of-stock, and more.

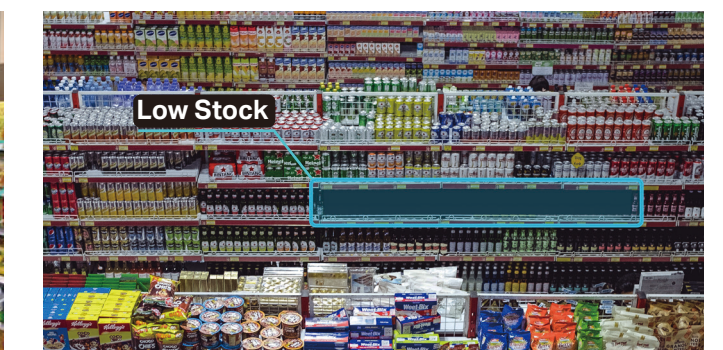

*These products and functions may be in development and may vary from displayed images and features.

Promote Benefits

VIGI is your powerful assistant to analyze what your customers are interested in and how to increase sales. AI-driven data collection and analysis support your activities with actionable data.

Get Insight into Your Customers

Real-Time People Counting

Counts the entrance and exit of customers with high accuracy via the VIGI Dual Lens People Counting Camera and AI algorithm.

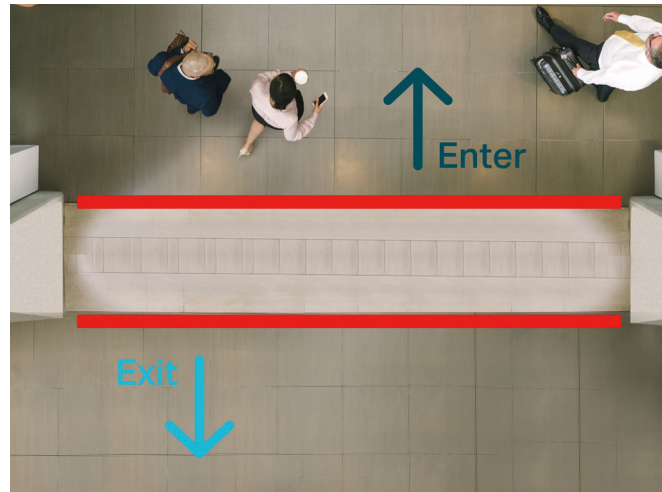

AI Heat Map*

Easily identify areas that clients frequent more as well as the "dead zones" in your store.

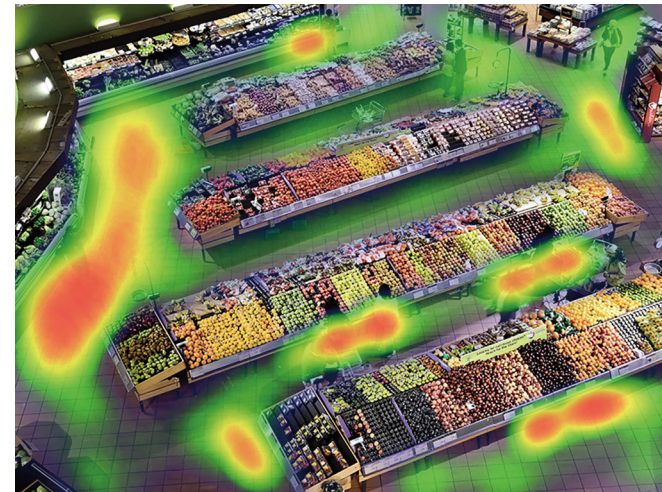

Pathway Analysis*

Find high-traffic locations from the routes of customers and make best use of them to maximize sales.



Customer Flow Analysis*

Illustrates traffic data by type, time, and area for your analysis and summarizes the marketing activities with high efficiency.

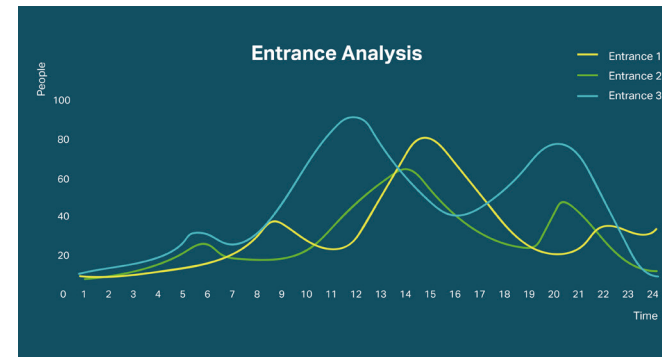

Efficient Trading Record and Management

Integrates POS information and video display in Live View and Playback. Search with text to identify transactions and cross-reference them with video.

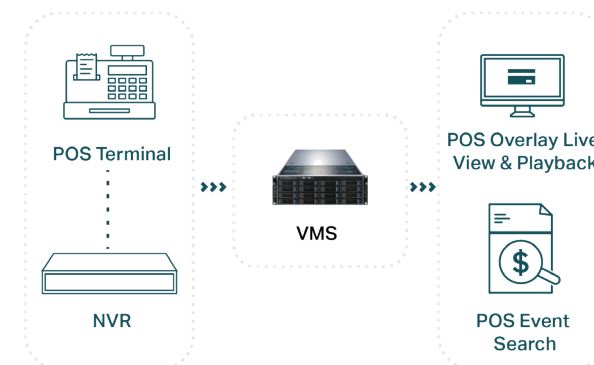

Recommended Products

Network Camera

Entrance



VIGI C380P

Dual Lens Wide Angle Camera

- Almost **180° FOV** with **8MP** resolution
- **Smart image distortion correction**
- **24-hour colorful imaging**
- Smart detection & instant notifications
- **IP67** protection



VIGI C640

Dual Lens People Counting Camera

- **AI people counting**
- Smart detection & instant notifications
- **Compact design**
- **PoE** for simple wiring

Checkout Counter



VIGI C240I

4MP IR Dome Network Camera

- **2K** (Quad HD) resolution
- Vandal proof (**IK10**)
- **2.8mm lens** suitable for checkout counter
- **PoE** for simple wiring

Indoor Areas



VIGI C440I

4MP IR Turret Network Camera

- **2K** (Quad HD) resolution
- Accurate event alarms by **Human Classification**
- **Smart IR** for night monitoring
- **PoE** for simple wiring

Outdoor Areas



VIGI C540-W

4MP Outdoor Full-Color Wi-Fi Pan Tilt Camera

- Powerful pan tilt with **smart tracking** and **customized patrolling**
- **24-hour colorful imaging**
- **IP66** protection
- **Wi-Fi** connection
- **Onboard storage** (microSD card)



VIGI C340-W

4MP Outdoor Full-Color Bullet Network Camera

- **IP66** for outdoor scenarios
- **24-hour colorful imaging**
- Flexible **wall/ceiling/pole** mounting
- **Wi-Fi** connection
- **Onboard storage** (microSD card)

Storage & Management

Single-Site Shop



VIGI NVR1016H

16-Channel Network Video Recorder

- **16** channels
- Max **4K** resolution for one channel
- Up to **1x 10TB** HDD
- **H.265+** for efficient video storage and decoding

Chain Shops



VIGI NVR1008H-8MP

8-Channel PoE+ Network Video Recorder

- **8-channel PoE+** ports (802.3af/at)
- Max **4K** resolution for one channel
- Up to **1x 10TB** HDD
- **H.265+** for efficient video storage and decoding



VIGI NVR4032H

32-Channel Network Video Recorder

- **32** channels with sufficient bandwidth (**320 Mbps**)
- Max **8K** resolution for one channel
- Up to **4x 10TB** HDDs
- **H.265+** for efficient video storage and decoding



VIGI NVD6004

Network Video Decoder

- **4x 4K** video output (3840x2160@30Hz)
- Decode up to **64-ch@1080P** cameras simultaneously
- Max **4** HDMI ports
- **Web UI / VMS** management

*These products and functions may be in development, and may vary from displayed images and features.

Education

Boarding Schools | Universities



Challenges

Education administrators are facing security challenges from students, staff, as well as facilities in multiple aspects. This requires a comprehensive surveillance solution to discover and respond to incidents and potential risks in time.

- Dangerous Behaviors
- School Violence
- Human & Vehicle Management

Solution Overview

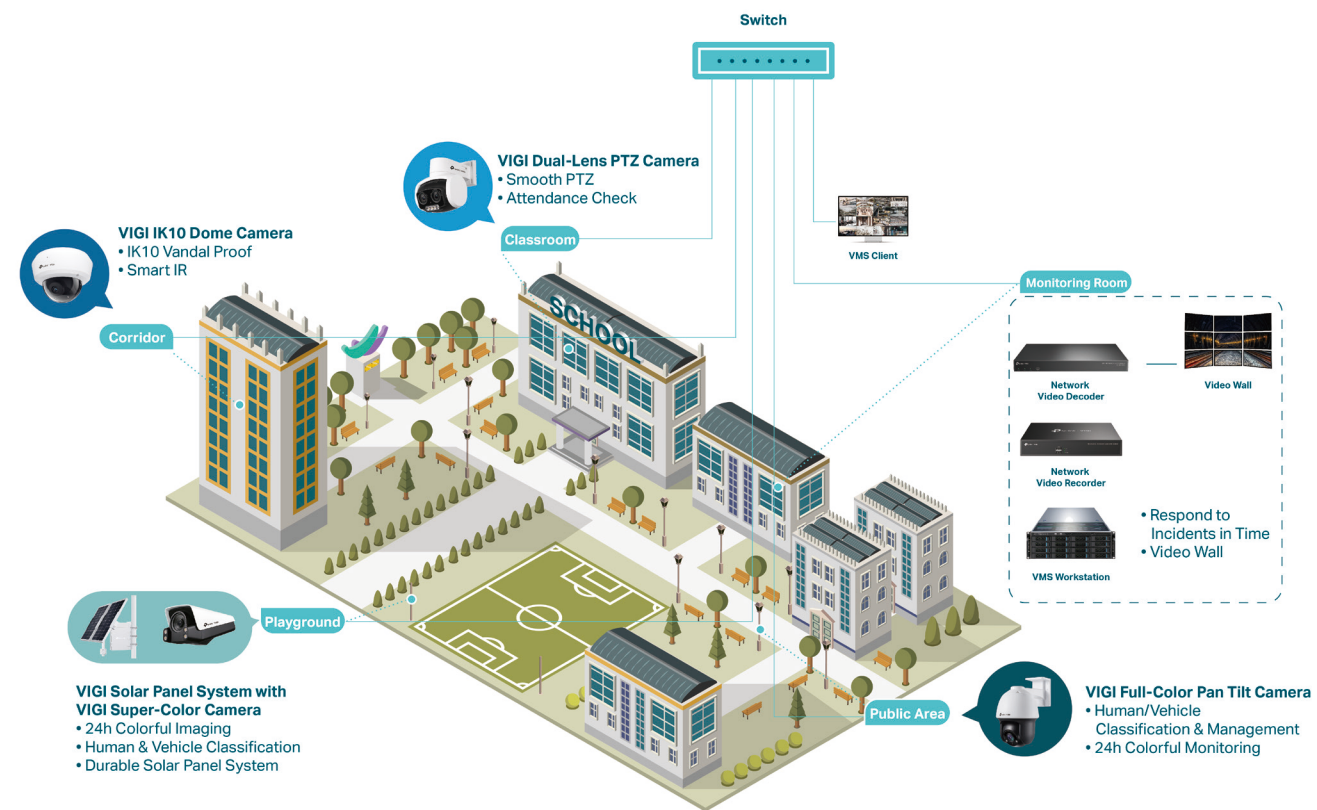

Highlights

Respond to Incidents in Time

VIGI assists your security personnel to deal with issues efficiently and conveniently. No matter when and where, VIGI informs your team with customized alarm mechanisms and dynamic mapping.

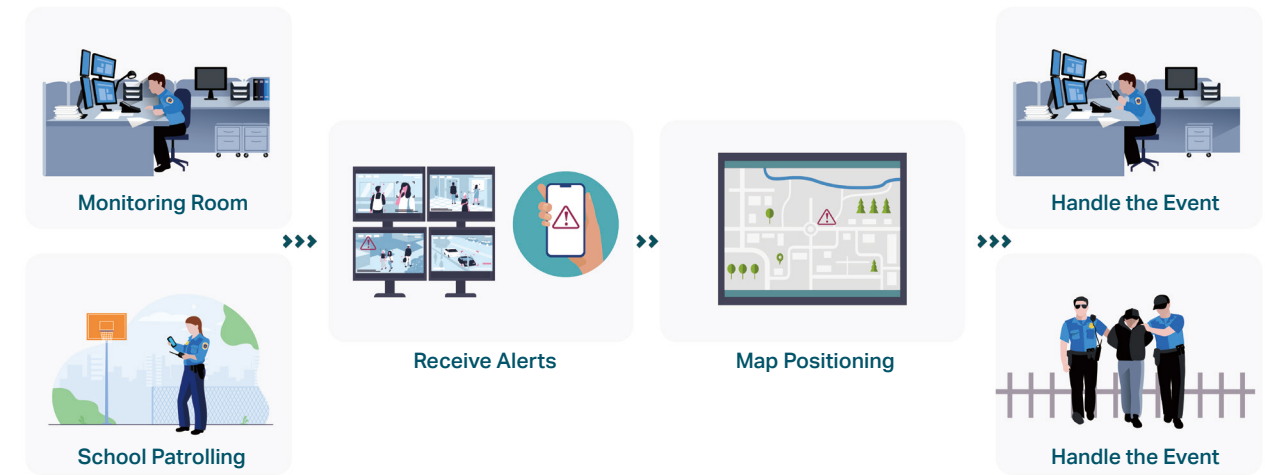

Proactively Deter Threats

VIGI AI algorithms detect various security issues to protect your school from human, vehicle, and area events.

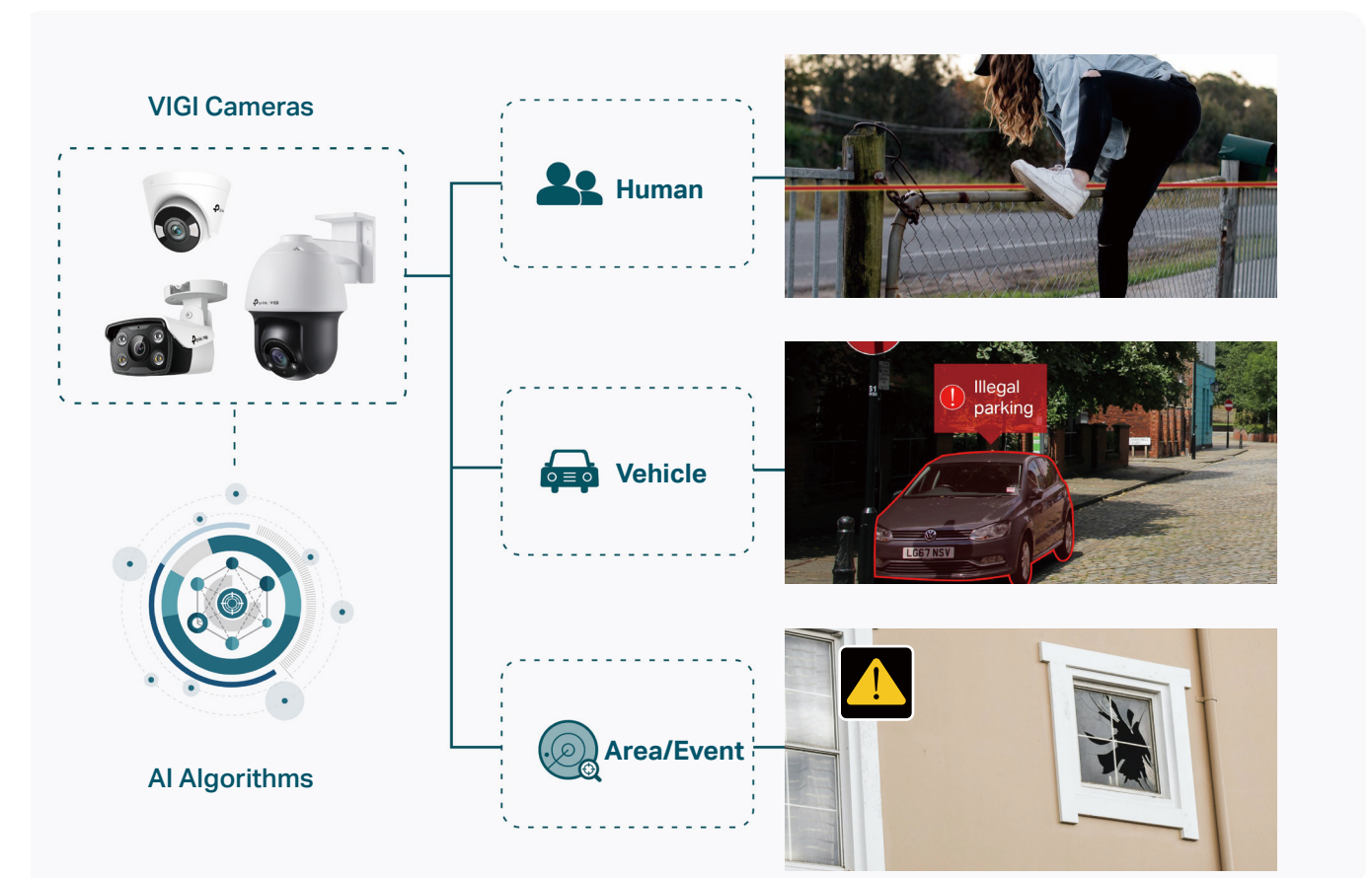

Human Management*

From school security to attendance, VIGI offers face recognition solutions for more efficient and accurate management.

Access Management**

Recognizes and classifies visitors, students, and staff to ensure visitors register and enhance school security.

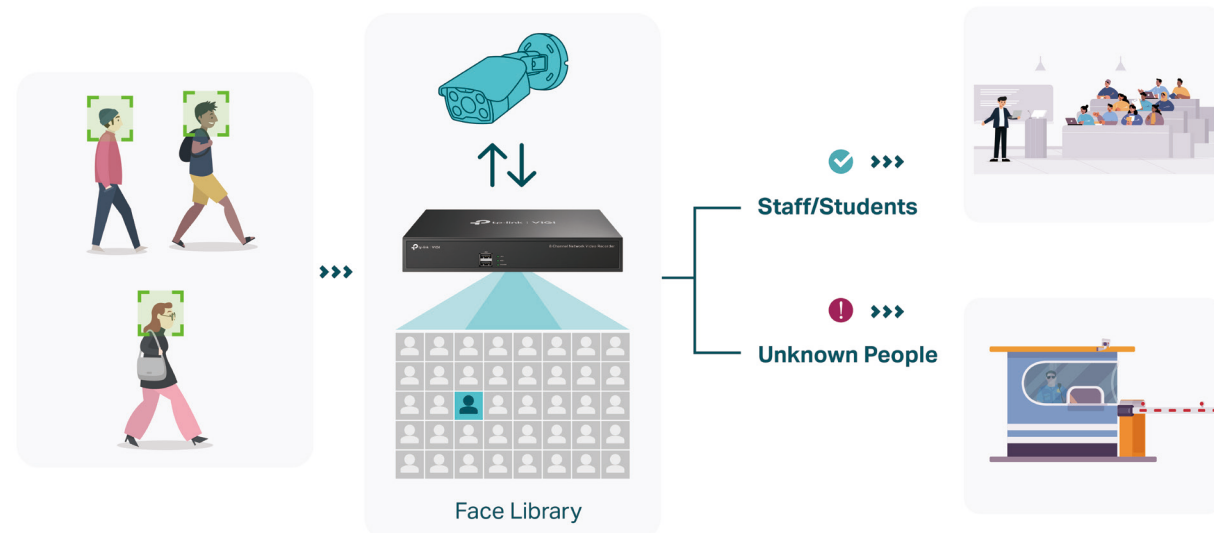

Attendance Check

Detects if students are late or absent from classes for simple and efficient class management.

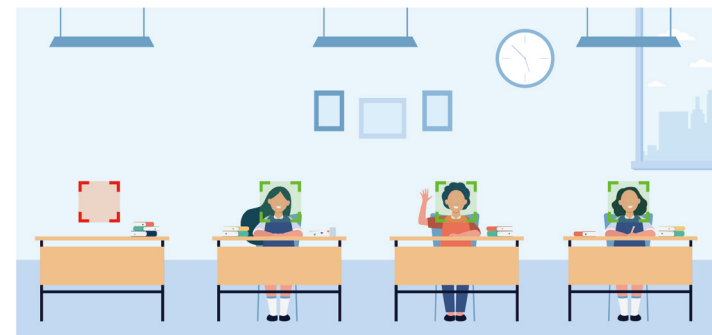

Vehicle Management**

Identifies staff vehicles, school buses, and more for simple vehicle management. Intelligently monitors parking status and notifies you when the fire escape is blocked.

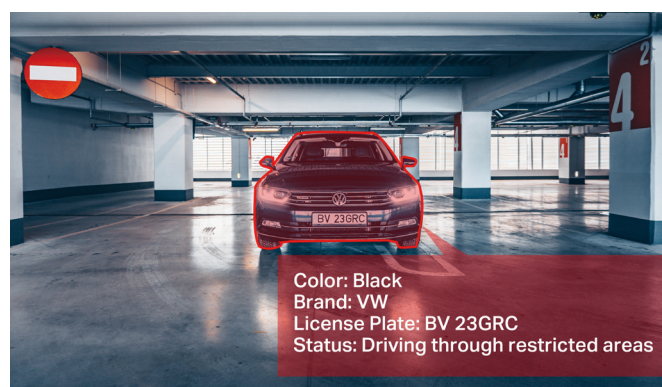

Recommended Products

Network Camera

Corridor/Classroom



VIGI C2401
4MP IR Dome Network Camera

- **2K** (Quad HD) resolution
- Vandal proof (**IK10**)
- **PoE** for simple wiring
- Smart IR night monitoring

Outdoor areas



VIGI C540V
4MP Dual Lens Varied Focal Full-Color Pan Tilt Network Camera

- **2K** (Quad HD) resolution
- **4 to 12mm** varied focal lens
- **Smooth lens switching**
- **Smart tracking & customized patrolling**
- **24-hour colorful monitoring**
- **IP66** protection

Playground



VIGI C340S
4MP Outdoor Super-Color Bullet Network Camera

- **24-hour colorful monitoring** (min. illumination: 0.0005Lux)
- **120 dB WDR**
- **IP67** for outdoor scenarios
- Flexible **wall/ceiling/pole** mounting
- **Onboard storage** (microSD card)

Outdoor Areas



VIGI C540
4MP Outdoor Full-Color Pan Tilt Network Camera

- Powerful pan tilt with **smart tracking** and **customized patrolling**
- **24-hour colorful monitoring**
- **IP66** protection
- **PoE** for simple wiring
- **Onboard storage** (microSD card)

Network Video Decoder



VIGI NVR8064H
64-Channel Network Video Recorder

- **64** channels with sufficient bandwidth (**480 Mbps**)
- Max **8K** resolution for one channel
- Up to **8x 10TB** HDDs
- **H.265+** for efficient video storage and decoding



VIGI NVR4032H
32-Channel Network Video Recorder

- **32** channels with sufficient bandwidth (**320 Mbps**)
- Max **8K** resolution for one channel
- Up to **4x 10TB** HDDs
- **H.265+** for efficient video storage and decoding

Network Video Decoder



VIGI NVD6012
Network Video Decoder

- **12x 4K** video output (3840x 2160@ 30Hz)
- Decode up to **192-ch@1080P** cameras simultaneously
- Max **12** HDMI ports
- **Web UI / VMS** System management



VIGI NVD6004
Network Video Decoder

- **4x 4K** video output (3840x 2160@ 30Hz)
- Decode up to **64-ch@1080P** cameras simultaneously
- Max **4** HDMI ports
- **Web UI / VMS** System management

Video Management System



VMS Workstation

- Max **10,000** registered / **100** logged-in users
- Max **5,000** input channels & **768** output channels
- **Area/Devices/Role** Management
- Dynamic Map/Live Video Streaming

Solar Panel System



VIGI PT8848+SP9030

- **90W** solar panel
- **30AH** ternary lithium battery
- **4K (8MP)** resolution
- Durable hardware design

*Feature availability dependent on country and region. Please follow local laws and regulations where applicable.
**These products and functions may be in development, and may vary from displayed images and features

Hospitality

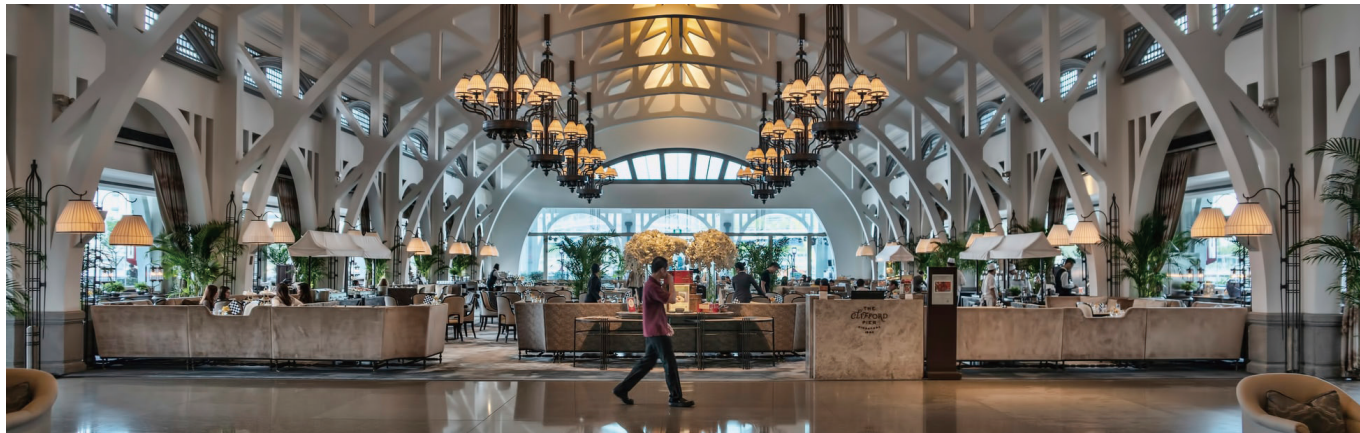

Challenges

Surveillance systems for the hospitality industry should first ensure the security of guests and properties. The scenarios usually have strong fluidity of people, which increase the risks of safety issues. Management should therefore consider maintaining a large amount of surveillance devices.



Complicated Personnel



Mass Monitoring Videos



Hard to Extend

Solution Overview

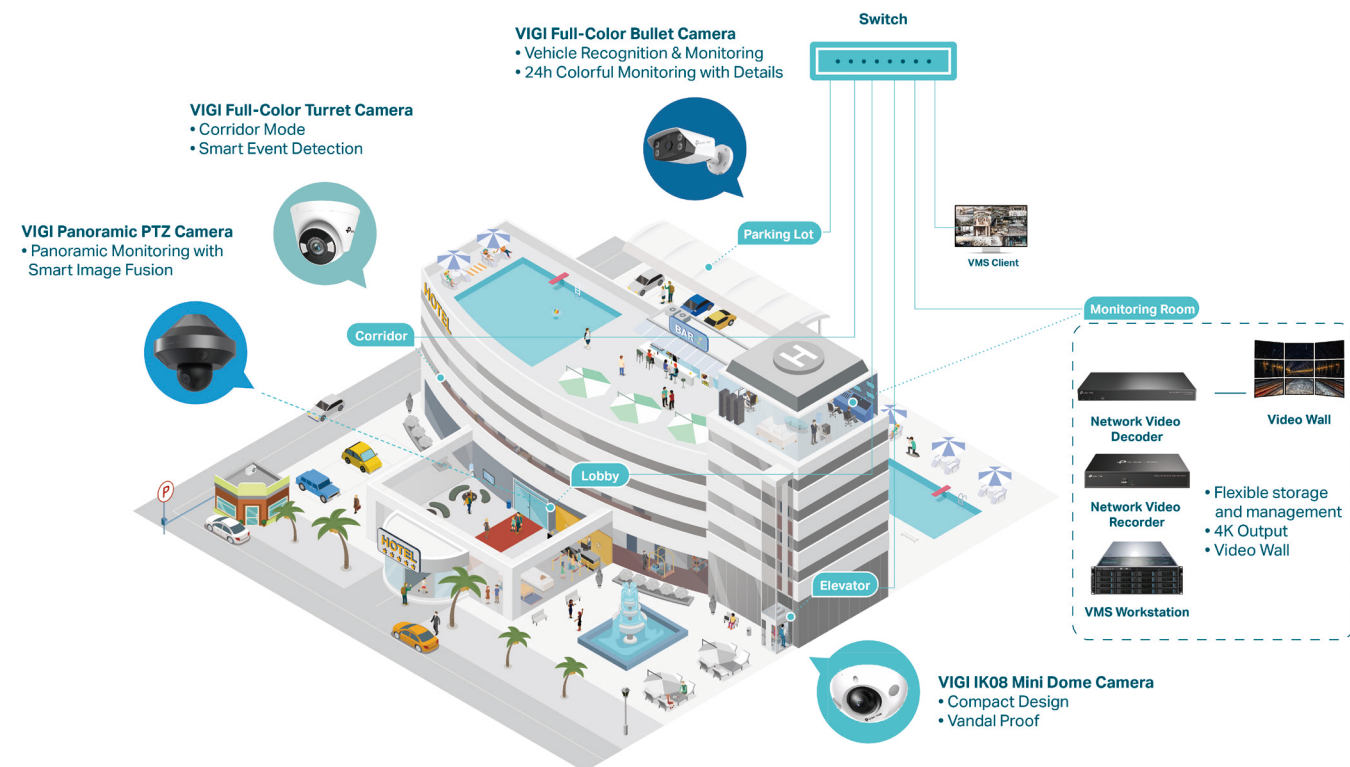

Highlights

Professional AI Event Detection

VIGI builds strong awareness of events with AI in multiple scenarios all the time to protect people and property. With advanced AI algorithms, our system intelligently detects various events of people, vehicles, and key areas and accurately notifies you.

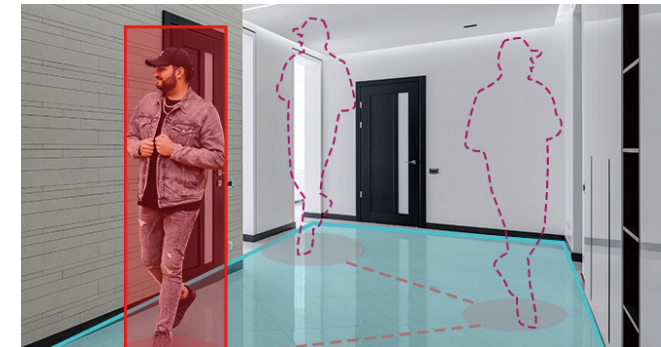

Loitering Detection



Abandoned Object Detection

Practical Features Specialized for Hotels

Corridor Mode

One click to focus on the key area in the corridor and improve monitoring efficiency.

PTZ Panoramic*

Monitor the lobby with 360° full view and details. VIGI two-in-one cameras efficiently combine the panoramic and close-up views and take zero switching time.

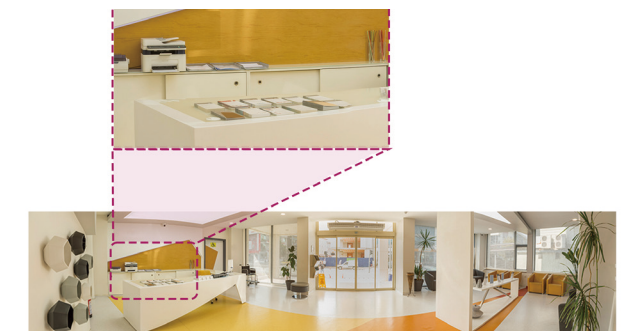

Vehicle Management*

Recognizes and records vehicle information for simple vehicle management, including license plates, color, and type. Quickly search videos for a specified car via Smart Search.



*These products and functions may be in development, and may vary from displayed images and features.

Efficient Event Backtracking

Quickly brings up specified clips from a huge number of videos and review events with VIGI's practical filter and smart timeline. Keep your videos on the cloud with reliable storage and quick access when needed.

Practical Filter

Search videos with VIGI's abundant filter types, including event type, characteristics of person/vehicle, area, and tag.



Smart Timeline

Take a quick look and know what happened during a time period with VIGI Smart Timeline. VIGI intelligently tags the clips that need to be noticed, and show the thumbnails to overview the whole timeframe.

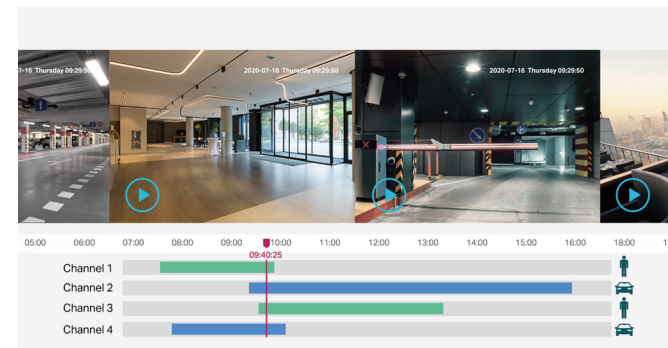

Reliable Cloud Storage

Enjoy fast and durable storage of massive videos on the cloud with the VIGI surveillance system. Check feedback at anytime and anywhere with secure and reliable access.

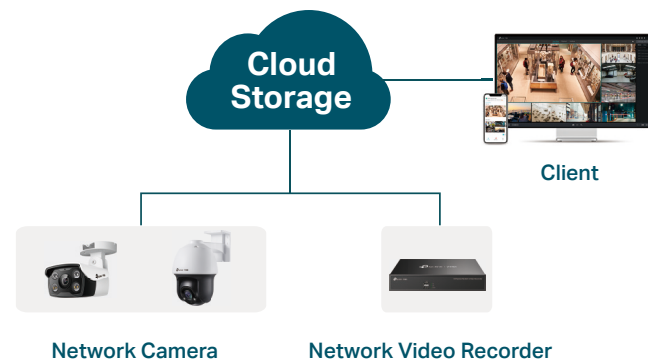

Extensible Security Management

The VIGI Cloud VMS solution supports your business to grow. Deploy surveillance networks in your new chain hotels and add the sites and devices easily and flexibly with the system.

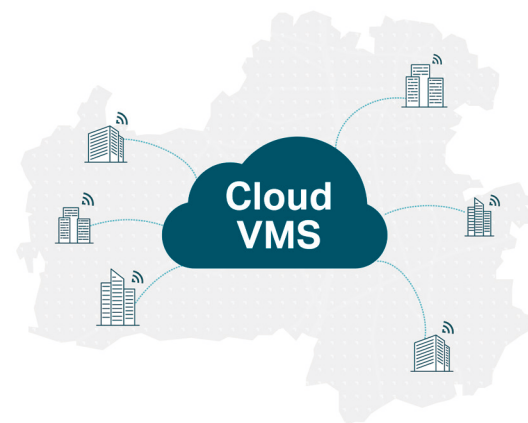

Recommended Products

Network Cameras

Corridor



VIGI C440

4MP Full-Color Turret Camera

- **Corridor Mode** to focus on key areas
- **24-hour colorful imaging**
- Loitering Detection/ Abandoned Object Detection
- **PoE** for simple wiring

Elevator



VIGI C230I Mini

3MP IR Mini Dome Network Camera

- Vandal proof (**IK08**)
- Compact design
- Abandoned Object Detection
- **PoE** for simple wiring

Lobby



VIGI C9C0-PTZ

Panoramic Full-Color PTZ

- **360° FOV** with **12MP** resolution
- Panoramic camera linked to a PTZ
- **24-hour** colorful imaging
- Smart detection & instant notifications
- **IP66** protection

Parking Lot



VIGI C340-W

4MP Outdoor Full-Color Bullet Network Camera

- **IP67** for outdoor scenarios
- **24-hour colorful imaging**
- **Vehicle Classification**
- **PoE** for simple wiring

Outdoor Areas



VIGI C540S

4MP Super-Color Pan Tilt Camera

- **24-hour colorful imaging without supplemental lights**
- **Powerful pan tilt**
- Smart detection & instant notifications
- **IP66** protection
- **Onboard storage** (microSD card)

Solar Panel System



VIGI C340S + SP9030

- **90W** solar panel
- **30AH** ternary lithium battery
- **24-hour colorful imaging without supplemental lights**
- **IP67** protection

Network Video Decoder



VIGI NVR4032H

32-Channel Network Video Recorder

- **32** channels with sufficient bandwidth (**320 Mbps**)
- Max **4K** resolution for one channel
- Up to **4x 10TB** HDDs
- **H.265+** for efficient video storage and decoding

Network Video Recorder



VIGI NVD6004

Network Video Decoder

- **4x 4K** video output (3840x 2160@ 30Hz)
- Decode up to **64-ch@1080P** cameras simultaneously
- Max **4** HDIM Ports
- **Web UI / VMS** management

*These products and functions may be in development, and may vary from displayed images and features.

VIGI Network Camera

- AI Detection
- 24h Colorful Imaging
- Efficient Monitoring



Highlights

Human

Accurate detection allows for quick action with intelligent recognition of people and related features.

- Loitering Detection*
- Person Attribute Detection
- Facial Recognition**

Vehicle

Get multiple attributes of vehicles with AI detection for quick search and easy management.

- License Plate
- Color
- Vehicle Type



Business Insight

Intelligent analysis supports your business and helps you learn more about your customers.

- People Counting
- Density Heat Map
- Queue Detection*

Area/Event

Strong awareness of events and areas based on a combination of detection methods.

- Abundant Object Detection
- Abnormal Voice Detection*
- Departure Monitoring*
- Smoke Detection*
- Area Intrusion

Accurate Classification

Human & Vehicle Classifications

Accurately detect subjects using VIGI AI learning algorithms with intelligent recognition of human/vehicle and related features.

Stable Classification

Clearly recognizes humans and vehicles regardless of weather and light even on cloudy, rainy, foggy days, or behind glass.



High Accuracy

Accurately recognizes human motion, even if the subject isn't in full view.



Long Distance

Detects humans and vehicles from long distance to never miss anything important.

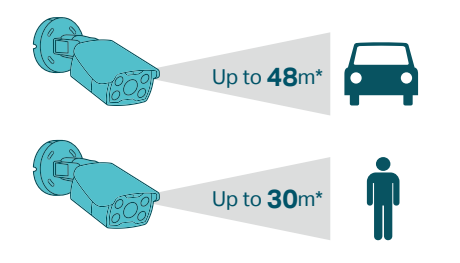

Lineup

Resolution	Camera Type				
	Dome	Bullet	Turret	PT	Special
5MP+		VIGI C380P* 8MP Panoramic Full-Color Bullet, IP67		VIGI PT8848* 8MP High Speed PTZ, IP66	
				VIGI C9C0-PTZ* 12MP+4MP Panoramic Full-Color PTZ, IP66	
	VIGI C280* 8MP Full-Color Dome, IP67, IK10	VIGI C380* 8MP Full-Color Bullet, IP67	VIGI C480* 8MP Full-Color Turret, IP67	VIGI C580* 8MP Full-Color PT, IP66	
4MP	VIGI C250* 5MP Full-Color Dome, IP67, IK10	VIGI C350* 5MP Full-Color Bullet, IP67	VIGI C450* 5MP Full-Color Turret, IP67	VIGI C550* 5MP Full-Color PT, IP66	
		VIGI C340V* 4MP Dual-Lens Varied Focal Full-Color Bullet, IP67		VIGI C540V* 4MP Dual-Lens Varied Focal Full-Color PT, IP66	
	VIGI C240S* 4MP Super-Color Dome, IP67, IK10	VIGI C340S* 4MP Super-Color Bullet, IP67	VIGI C440S* 4MP Super-Color Turret		
3MP	VIGI C240 4MP Full-Color Dome, IP67, IK10	VIGI C340 4MP Full-Color Bullet, IP66	VIGI C440 4MP Full-Color Turret	VIGI C540 4MP Full-Color PT, IP66	VIGI C640* 4MP Dual-Lens People Counting Network Camera
	VIGI C240I 4MP IR Dome, IP67, IK10	VIGI C340I 4MP IR Bullet, IP67	VIGI C440I 4MP IR Turret	VIGI C540-4G 4MP Full-Color 4G PT, IP66	4MP Full-Color PT Solar Powered 4G Network Camera Kit
	VIGI C230 3MP Full-Color Dome, IP67, IK10	VIGI C330 3MP Full-Color Bullet, IP67	VIGI C430 3MP Full-Color Turret		
	VIGI C230I 3MP IR Dome, IP67, IK10	VIGI C330I 3MP IR Bullet, IP67	VIGI C430I 3MP IR Turret		
2MP	VIGI C230I Mini 3MP IR Mini Dome, IK8	VIGI C300HP 3MP IR Bullet, IP67	VIGI C400HP 3MP IR Turret		
	VIGI C220I 2MP IR Dome, IP67, IK10	VIGI C320I 2MP IR Bullet, IP67	VIGI C420I 2MP IR Turret		

*These products and functions may be in development and may vary from displayed images and features.

**Feature availability dependent on country and region. Please follow local laws and regulations where applicable.

Abnormal Sound Detection*

The deep learning AI acoustic algorithm automatically filters "noises," notifying you of safety events that require action and improves environmental safety.



License Plate Recognition*

Multiple Types

High-performance AI processes different types of licenses from various countries and regions.



Abnormal Data/Status

Intelligently recognizes plates in abnormal states, such as tilted, occluded, and defiled license plates.



Customized Detection

Supports a variety of configurations and combinations of features. Customize detection rules, sensitivity, area, target size, and more according to scene requirements to flexibly detect notable targets and reduce invalid alarms that do not need attention.

Hotel Corridor

Focus on human activities in areas with accurate detection, including area intrusion/exit, loitering time, person identifiers, and more.

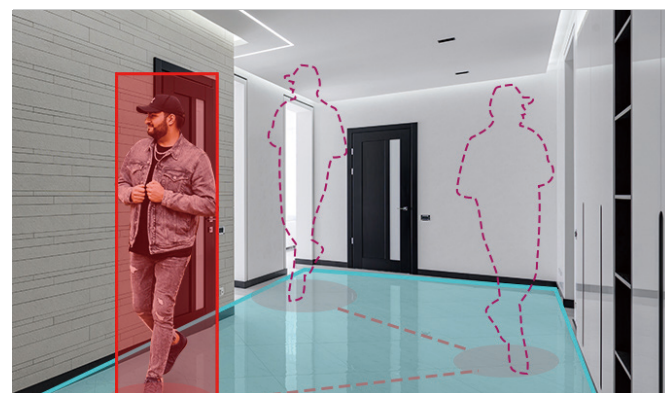

No-parking/Restricted Area

Pays more attention to events happening in restricted areas, such as illegal parking and trespassing.



High-Quality Imaging

VIGI developed its night monitoring technologies to secure every night. VIGI cameras with high-sensitive sensors maintain premium imaging at night, capturing more details and colors even in pitch-black conditions.



Naked Eyes



IR Night Vision Camera



VIGI Super-Color Camera*

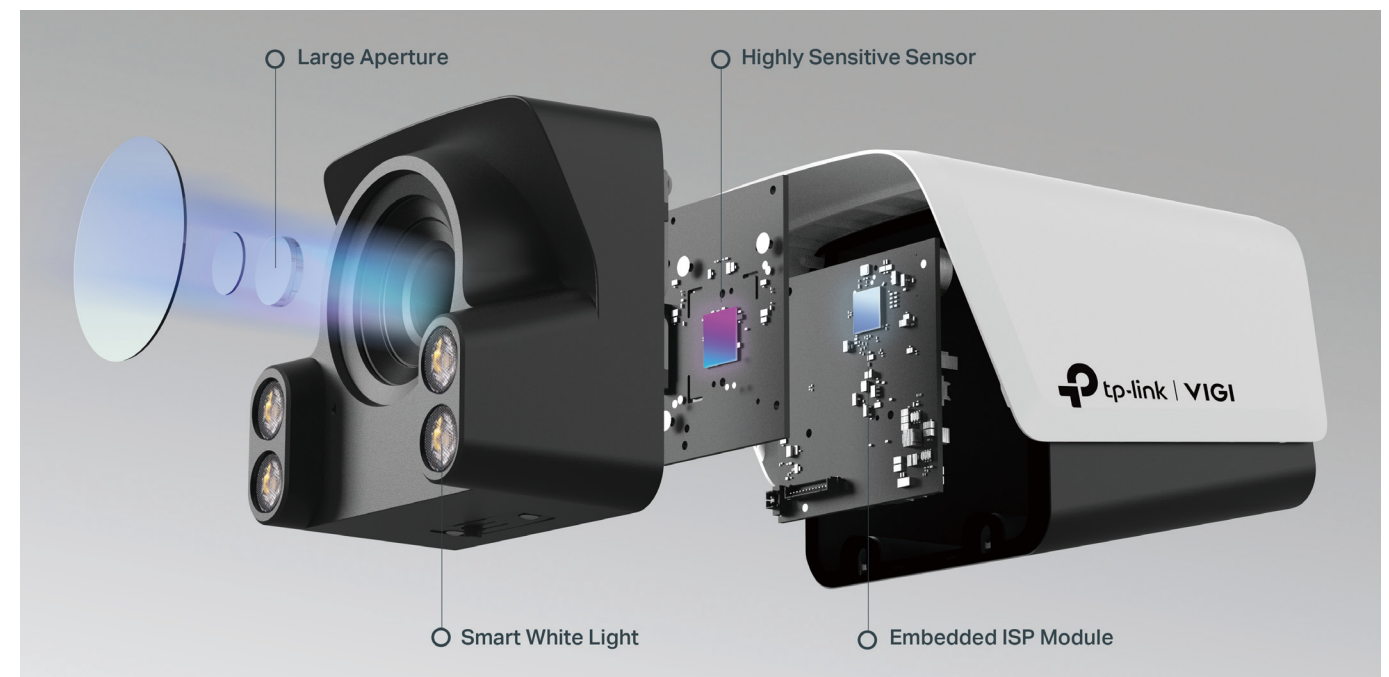

Large Aperture

Captures 4.5x more light** to support colorful imaging at night.

Smart White Light

Intelligent environment-based lighting mode for the best imaging all the time.

Highly Sensitive Sensor

Makes the best use of light and generates images with 45% improved performance** thanks to BSI technology.

Embedded ISP Module

Smart image-processing algorithms automatically enhance image quality.

Applications

Parking Lot

Reduces license plate reflections caused by infrared and accurately identifies vehicle features.



Entrance/Street

Identifies the characteristics of people and vehicles and avoids false alarms due to flying insects.



Park

Collect color information for improved security.



*These functions may be in development and may vary from displayed images and features.
**Calculations based on laboratory testing. Actual performance may vary according to the environment and other variables.

Smart Image Fusion

One VIGI camera assumes the work of two or more cameras. VIGI's superior image fusion technology effectively widens field of view, while intelligently correcting lens distortion.

Dual-Imaging Wide Angle Camera



Panoramic PTZ Camera



Clear & Smooth Zoom

VIGI reduces physical zoom movement with a unique algorithm, allowing 3x faster zooms and a longer lifetime. Captures more details farther away by seamlessly switching between two lenses.



Smart Video Enhancement

Up to 120 dB WDR

Identifies humans and vehicles with clear details. VIGI cameras with high dB value and smart area-based algorithms smartly prevent objects from being overexposed or underexposed.

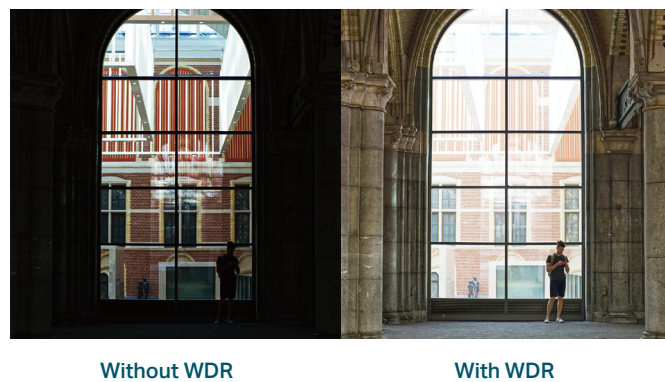

Smart IR

Automatically adjusts IR lights and keeps objects from being under-rendered when far away or washed out when close to the camera.

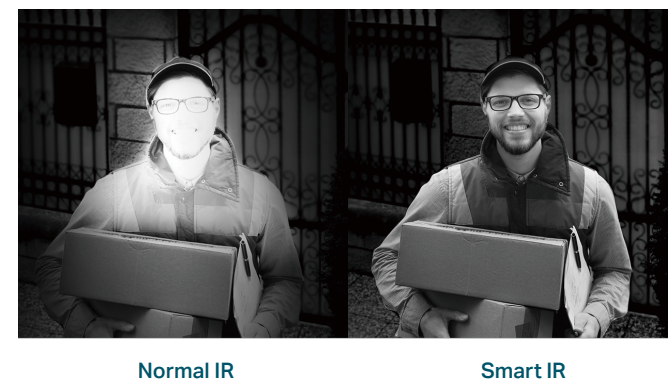

Efficient Monitoring

Active Defense

Smart alarms warn intruders or suspicious people based on the time, area, event and act.



Two-Way Audio

With voice intercom support, carry two-way conversations while watching your feed from anywhere. Suitable for management.

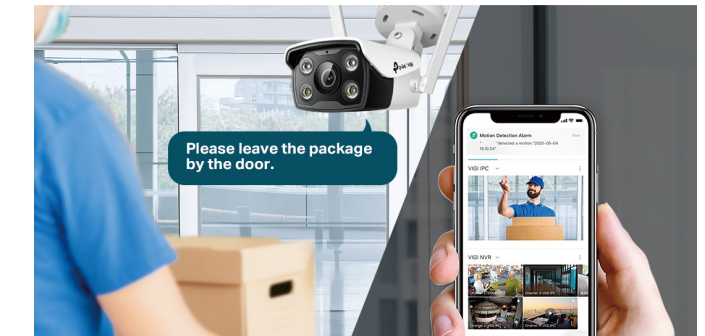

Automatic Tracking

Continues following specified moving persons or vehicles with Pan Tilt cameras intelligently analyzing the image. Track the path efficiently when there should be little movement in the area.

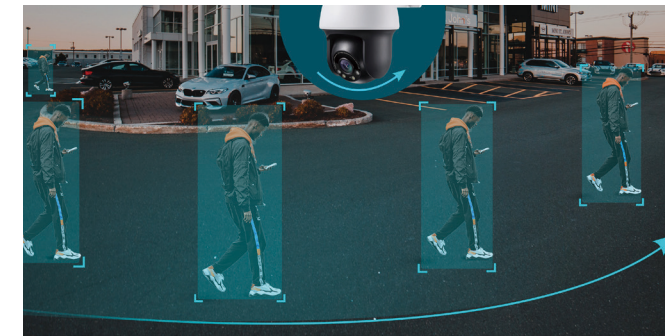

Customized Patrol

Quickly focuses on key areas with preset patrol points and routes (up to 8 points for each route).



IK10 / IP67 Protection

Meets the need of vandal resistance and outdoor surveillance with reliable hardware design and tests.



Remote Monitoring

Manage your security from the palm of your hand with the VIGI app.

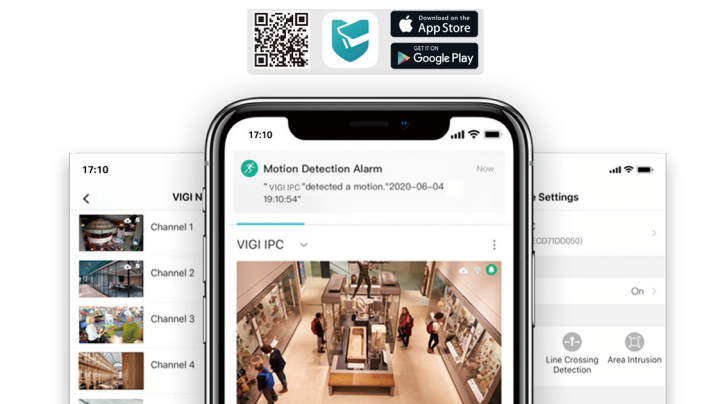

Specifications

Product Type	Bullet Camera											
Product Image												
Product Model	VIGI C380P*	VIGI C380*	VIGI C350*	VIGI C340V*	VIGI C340S*	VIGI C340**	VIGI C340-W**	VIGI C340-4G*	VIGI C330	VIGI C340I	VIGI C330I	VIGI C320I
Pixels	8MP	8MP	5MP	4MP	4MP	4MP	4MP	4MP	3MP	4MP	3MP	2MP
Image Sensor	1/3" Progressive Scan CMOS x 2	1/2.7" Progressive Scan CMOS	1/2.7" Progressive Scan CMOS	1/3" Progressive Scan CMOS	1/1.8" Progressive Scan CMOS	1/3" Progressive Scan CMOS	1/3" Progressive Scan CMOS	1/3" Progressive Scan CMOS	1/2.8" Progressive Scan CMOS	1/3" Progressive Scan CMOS	1/2.8" Progressive Scan CMOS	1/3" Progressive Scan CMOS
Aperture	F1.6	F1.6	F1.6	F1.6	F1.0	F1.6	F1.6	F1.6	F1.6	F2.0 (6mm) F2.2 (2.8/4mm)	F2.0 (4/6mm) F2.2 (2.8mm)	F2.0 (4/6mm) F2.2 (2.8mm)
Focal Length	4mm	2.8mm/4mm/6mm	2.8mm/4mm/6mm	4mm to 12mm	2.8mm/4mm/6mm	2.8mm/4mm/6mm	4mm	4mm	2.8mm/4mm/6mm	2.8mm/4mm/6mm	2.8mm/4mm/6mm	2.8mm/4mm/6mm
Min. Illumination	Color: 0.005 Lux; 0 Lux with IR/white light	Color: 0.005 Lux; 0 Lux with IR/white light	Color: 0.005 Lux; 0 Lux with IR/white light	Color: 0.005 Lux; 0 Lux with IR/white light	Color: 0.0005 Lux; 0 Lux with white light	Color: 0.005 Lux; 0 Lux with IR/white light	Color: 0.005 Lux; 0 Lux with IR/white light	Color: 0.005 Lux; 0 Lux with IR/white light	Color: 0.005 Lux; 0 Lux with IR/white light	Color: 0.1 Lux; 0 Lux with IR	Color: 0.1 Lux; 0 Lux with IR	Color: 0.1 Lux; 0 Lux with IR
Video Compression	H.265+/H.264+/H.265/H.264	H.265+/H.264+/H.265/H.264	H.265+/H.264+/H.265/H.264	H.265+/H.264+/H.265/H.264	H.265+/H.264+/H.265/H.264	H.265+/H.264+/H.265/H.264	H.265+/H.264+/H.265/H.264	H.265+/H.264+/H.265/H.264	H.265+/H.264+/H.265/H.264	H.265+/H.264+/H.265/H.264	H.265+/H.264+/H.265/H.264	H.265+/H.264+/H.265/H.264
Smart Detection***	•	•	•	•	•	•	•	•	•	•	•	•
Human & Vehicle Classification	•	•	•	•	•	•	•	•	•	•	•	•
Facial Recognition	•	•	•	•	•	•	•	•	•	•	•	•
SmartVid	•	•	•	•	•	•	•	•	•	•	•	•
WDR	DWDR	120dB	120dB	DWDR	DWDR	DWDR	DWDR	DWDR	DWDR	DWDR	DWDR	DWDR
IR Range	30 m	30 m	30 m	30 m	-	30 m	30 m	30 m	30 m	30 m	30 m	30 m
White Light Range	30 m	30 m	30 m	30 m	30 m	30 m	30 m	30 m	30 m	-	-	-
Built-In Microphone	•	•	•	•	•	•	•	•	•	•	•	•
Built-In Speaker	•	•	•	•	•	•	•	•	•	•	•	•
Micro-SD Card Slot	•	•	•	•	•	•	•	•	•	•	•	•
Network	Ethernet	Ethernet	Ethernet	Ethernet	Ethernet	Ethernet	Wi-Fi/Ethernet	4G/Ethernet	Ethernet	Ethernet	Ethernet	Ethernet
Protection	IP67	IP67	IP67	IP67	IP67	IP67	IP67	IP66	IP67	IP67	IP67	IP67
Power Supply	DC 12V; PoE	DC 12V; PoE	DC 12V; PoE	DC 12V; PoE	DC 12V; PoE	DC 12V; PoE	DC 12V	DC 12V	DC 12V; PoE	DC 12V; PoE	DC 12V; PoE	PoE

Product Type	Dome Camera									
Product Image										
Product Model	VIGI C280	VIGI C250	VIGI C240S*	VIGI C240	VIGI C230	VIGI C240I	VIGI C230I	VIGI C220I	VIGI C230I Mini	VIGI C230I Mini
Pixels	8MP	5MP	4MP	4MP	3MP	4MP	3MP	2MP	3MP	3MP
Image Sensor	1/2.7" Progressive Scan CMOS	1/2.7" Progressive Scan CMOS	1/1.8" Progressive Scan CMOS	1/3" Progressive Scan CMOS	1/2.8" Progressive Scan CMOS	1/3" Progressive Scan CMOS	1/2.8" Progressive Scan CMOS	1/3" Progressive Scan CMOS	1/2.8" Progressive Scan CMOS	1/2.8" Progressive Scan CMOS
Aperture	F1.6	F1.6	F1.0	F1.6	F1.6	F2.2	F2.0 (4mm) F2.2 (2.8mm)	F2.0 (4mm) F2.2 (2.8mm)	F1.6	F1.6
Focal Length	2.8mm/4mm	2.8mm/4mm	2.8mm/4mm	2.8mm/4mm	2.8mm/4mm	2.8mm/4mm	2.8mm/4mm	2.8mm/4mm	2.8mm	2.8mm
Min. Illumination	Color: 0.005 Lux; 0 Lux with IR/white light	Color: 0.005 Lux; 0 Lux with IR/white light	Color: 0.0005 Lux; 0 Lux with white light	Color: 0.005 Lux; 0 Lux with IR/white light	Color: 0.005 Lux; 0 Lux with IR/white light	Color: 0.1 Lux; 0 Lux with IR	Color: 0.1 Lux; 0 Lux with IR	Color: 0.1 Lux; 0 Lux with IR	Color: 0.1 Lux; 0 Lux with IR	Color: 0.1 Lux; 0 Lux with IR
Video Compression	H.265+/H.264+/H.265/H.264	H.265+/H.264+/H.265/H.264	H.265+/H.264+/H.265/H.264	H.265+/H.264+/H.265/H.264	H.265+/H.264+/H.265/H.264	H.265+/H.264+/H.265/H.264	H.265+/H.264+/H.265/H.264	H.265+/H.264+/H.265/H.264	H.265+/H.264+/H.265/H.264	H.265+/H.264+/H.265/H.264
Smart Detection***	•	•	•	•	•	•	•	•	•	•
Human & Vehicle Classification	•	•	•	•	•	•	•	•	•	•
Facial Recognition	•	•	•	•	•	•	•	•	•	•
SmartVid	•	•	•	•	•	•	•	•	•	•
WDR	120dB	120dB	120dB	DWDR	DWDR	DWDR	DWDR	DWDR	DWDR	DWDR
IR Range	30 m	30 m	-	30 m	30 m	30 m	30 m	30 m	30 m	30 m
White Light Range	30 m	30 m	30 m	30 m	30 m	-	-	-	-	-
Built-In Microphone	•	•	•	•	•	•	•	•	•	•
Built-In Speaker	•	•	•	•	•	•	•	•	•	•
Micro-SD Card Slot	•	•	•	•	•	•	•	•	•	•
Network	Ethernet	Ethernet	Ethernet	Ethernet	Ethernet	Ethernet	Ethernet	Ethernet	Ethernet	Ethernet
Protection	IP67, IK10	IP67, IK10	IP67, IK10	IP67, IK10	IP67, IK10	IP67, IK10	IP67, IK10	IP67, IK10	IP67, IK10	IK08
Power Supply	DC 12V; PoE	DC 12V; PoE	DC 12V; PoE	DC 12V; PoE	DC 12V; PoE	DC 12V; PoE	DC 12V; PoE	DC 12V; PoE	PoE	DC 12V; PoE

Specifications

Product Type	Turret Camera									
Product Image										
Product Model	VIGI C480*	VIGI C450*	VIGI C440S*	VIGI C440**	VIGI C440-W**	VIGI C430	VIGI C440I	VIGI C430I	VIGI C420I	VIGI C640*
Pixels	8MP	5MP	4MP	4MP	4MP	3MP	4MP	3MP	2MP	4MP
Image Sensor	1/2.7" Progressive Scan CMOS	1/2.7" Progressive Scan CMOS	1/1.8" Progressive Scan CMOS	1/3" Progressive Scan CMOS	1/3" Progressive Scan CMOS	1/2.8" Progressive Scan CMOS	1/3" Progressive Scan CMOS	1/2.8" Progressive Scan CMOS	1/3" Progressive Scan CMOS	1/3" Progressive Scan CMOS
Aperture	F1.6	F1.6	F1.0	F1.6	F1.6	F1.6	F2.2	F2.0 (4mm) F2.2 (2.8mm)	F2.0 (4mm) F2.2 (2.8mm)	F2.2
Focal Length	2.8mm/4mm	2.8mm/4mm	2.8mm/4mm	2.8mm/4mm	4mm	2.8mm/4mm	2.8mm/4mm	2.8mm/4mm	2.8mm/4mm	2.8mm
Min. Illumination	Color: 0.005 Lux; 0 Lux with IR/white light	Color: 0.005 Lux; 0 Lux with IR/white light	Color: 0.0005 Lux; 0 Lux with white light	Color: 0.005 Lux; 0 Lux with IR/white light	Color: 0.005 Lux; 0 Lux with IR/white light	Color: 0.005 Lux; 0 Lux with IR/white light	Color: 0.1 Lux; 0 Lux with IR	Color: 0.1 Lux; 0 Lux with IR	Color: 0.1 Lux; 0 Lux with IR	Color: 0.1 Lux; 0 Lux with IR
Video Compression	H.265+/H.264+/H.265/H.264	H.265+/H.264+/H.265/H.264	H.265+/H.264+/H.265/H.264	H.265+/H.264+/H.265/H.264	H.265+/H.264+/H.265/H.264	H.265+/H.264+/H.265/H.264	H.265+/H.264+/H.265/H.264	H.265+/H.264+/H.265/H.264	H.265+/H.264+/H.265/H.264	H.265+/H.264+/H.265/H.264
Smart Detection***	•	•	•	•	•	•	•	•	•	•
Human & Vehicle Classification	•	•	•	•	•	•	•	•	•	•
Facial Recognition	•	•	•	-	-	-	-	-	-	-
SmartVid	•	•	•	•	•	•	•	•	•	•
WDR	120dB	120dB	120dB	DWDR	DWDR	DWDR	DWDR	DWDR	DWDR	DWDR
IR Range	30 m	30 m	-	30 m	30 m	30 m	30 m	30 m	30 m	30 m
White Light Range	30 m	30 m	30m	30 m	30 m	30 m	-	-	-	-
Built-In Microphone	•	•	•	•	•	•	-	-	-	•
Built-In Speaker	•	•	•	•	•	•	-	-	-	•
Micro-SD Card Slot	•	•	•	•	•	•	-	-	-	•
Network	Ethernet	Ethernet	Ethernet	Ethernet	Wi-Fi/Ethernet	Ethernet	Ethernet	Ethernet	Ethernet	Ethernet
Protection	IP67	IP67	IP67	-	-	-	-	-	-	IP67
Power Supply	DC 12V; PoE	DC 12V; PoE	DC 12V; PoE	DC 12V; PoE	DC 12V	DC 12V; PoE	DC 12V; PoE	DC 12V; PoE	PoE	DC 12V; PoE

Product Type	Pan Tilt (Zoom) Camera									
Product Image										
Product Model	VIGI PT8848*	VIGI C9C0-PTZ*	VIGI C580	VIGI C550	VIGI C540S*	VIGI C540V*	VIGI C540	VIGI C540-W	VIGI C540-4G	VIGI C540-4G
Pixels	8MP	12MP+4MP	8MP	5MP	4MP	4MP	4MP	4MP	4MP	4MP
Image Sensor	1/1.8" Progressive Scan CMOS	1/3" Progressive Scan CMOS	1/2.7" Progressive Scan CMOS	1/2.7" Progressive Scan CMOS	1/1.8" Progressive Scan CMOS	1/3" Progressive Scan CMOS	1/3" Progressive Scan CMOS	1/3" Progressive Scan CMOS	1/3" Progressive Scan CMOS	1/3" Progressive Scan CMOS
Aperture	F1.55-F4.8	F1.6	F1.6	F1.6	F1.0	F1.6	F1.6	F1.6	F1.6	F1.6
Focal Length	48X	2.8mm*3+4mm-12mm	4mm	4mm	2.8mm/4mm	4mm to 12mm	4mm	4mm	4mm	4mm
Min. Illumination	Color: 0.0005 Lux; 0 Lux with white light	Color: 0.005 Lux; 0 Lux with IR/white light	Color: 0.005 Lux; 0 Lux with IR/white light	Color: 0.005 Lux; 0 Lux with IR/white light	Color: 0.0005 Lux; 0 Lux with white light	Color: 0.005 Lux; 0 Lux with IR/white light	Color: 0.005 Lux; 0 Lux with IR/white light	Color: 0.005 Lux; 0 Lux with IR/white light	Color: 0.005 Lux; 0 Lux with IR/white light	Color: 0.005 Lux; 0 Lux with IR/white light
Video Compression	H.265+/H.264+/H.265/H.264	H.265+/H.264+/H.265/H.264	H.265+/H.264+/H.265/H.264	H.265+/H.264+/H.265/H.264	H.265+/H.264+/H.265/H.264	H.265+/H.264+/H.265/H.264	H.265+/H.264+/H.265/H.264	H.265+/H.264+/H.265/H.264	H.265+/H.264+/H.265/H.264	H.265+/H.264+/H.265/H.264
Smart Detection***	•	•	•	•	•	•	•	•	•	•
Human & Vehicle Classification	•	•	•	•	•	•	•	•	•	•
Facial Recognition	•	•	•	•	•	-	-	-	-	-
SmartVid	•	•	•	•	•	•	•	•	•	•
WDR	120dB	120dB	120dB	120dB	120dB	DWDR	DWDR	DWDR	DWDR	DWDR
IR Range	-	30 m	30 m	30 m	-	30 m	30 m	30 m	30 m	30 m
White Light Range	30 m	30 m	30 m	30 m	-	30 m	30 m	30 m	30 m	30 m
Built-In Microphone	•	•	•	•	•	•	•	•	•	•
Built-In Speaker	•	•	•	•	•	•	•	•	•	•
Micro-SD Card Slot	•	•	•	•	•	•	•	•	•	•
Network	Ethernet	Ethernet	Ethernet	Ethernet	Ethernet	Ethernet	Ethernet	Wi-Fi/Ethernet	4G/Ethernet	4G/Ethernet
Protection	IP66	IP66	IP66	IP66	IP66	IP66	IP66	IP66	IP66	IP66
Power Supply	DC 12V; PoE	DC 12V; PoE	DC 12V; PoE	DC 12V; PoE	DC 12V; PoE	DC 12V; PoE	DC 12V; PoE	DC 12V; PoE	DC 12V	DC 12V

*These products may be in development. Actual products may vary from displayed images and features.

**Functions of these products may slightly vary based on product version.

***Smart Detection refers to multiple AI detections and may vary based on product versions. AI detections include Abandoned Object Detection, Object Removal Detection, Area Entrance Detection, Area Exiting Detection, Vehicle Detection, and Human Detection.

Network Video Recorder



Face Library Management**

Quickly captures and filters faces by image/features from data collected by VIGI advanced AI technology and face management functions.

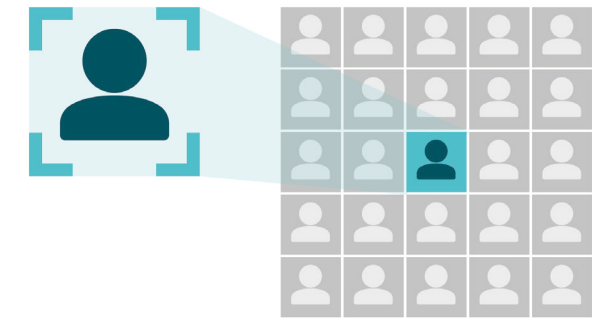

Plug & Play

Quickly create a security system by connecting your camera with VIGI PoE NVR via an Ethernet cable. UPnP and ONVIF allows VIGI NVR to add cameras from different vendors.



Simultaneous Playback

Replay the feed from up to 16 channels at the same time with practical playback tools, such as playing video clips of events only.

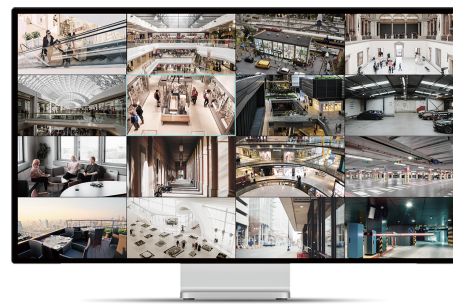

Efficient Storage

Processes compressed crystal-clear video faster, which also saves disk space, eases your network load, and reduces networking cost without sacrificing image quality.

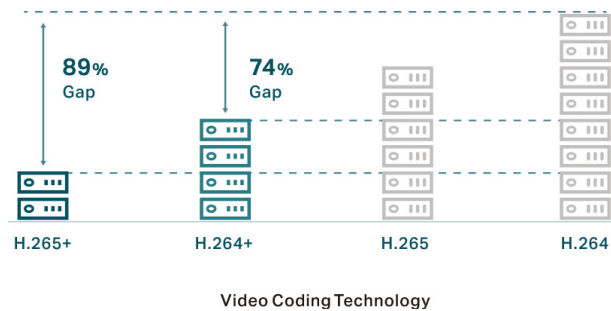

Smart Search

Efficiently search out and review certain video clips by event, vehicle, person, time, and more.



Simple Management

Enjoy efficient device maintenance and management with VIGI NVR software, such as upgrading the firmware of your devices in batch with just one click, and resetting your NVR's password quickly with the VIGI app and QR code.



Instant Notifications

Informs you as soon as an event happens with various forms of notifications, no matter when and where.



Specifications

Product Type	Non-PoE NVR							
Product Image								
Product Model	VIGI NVR8096H*	VIGI NVR8064H*	VIGI NVR4064H*	VIGI NVR4032H	VIGI NVR1016H-AI	VIGI NVR1016H	VIGI NVR1008H-AI	VIGI NVR1008H
Network Video Access Bandwidth	480Mbps	480Mbps	320 Mbps	320 Mbps	80 Mbps	80 Mbps	80 Mbps	80 Mbps
Network Video Input	96 channels	64 channels	64 channels	32 channels	16 channels	16 channels	8 channels	8 channels
PoE Interface	-	-	-	-	-	-	-	-
Video Compression	H.265+/H.264+/H.265/H.264	H.265+/H.264+/H.265/H.264	H.265+/H.264+/H.265/H.264	H.265+/H.264+/H.265/H.264	H.265+/H.264+/H.265/H.264	H.265+/H.264+/H.265/H.264	H.265+/H.264+/H.265/H.264	H.265+/H.264+/H.265/H.264
Smart Analysis	Facial Detection and Analytics/ Human/Vehicle Analysis	Facial Detection and Analytics/ Human/Vehicle Analysis	Facial Detection and Analytics/ Human/Vehicle Analysis	Facial Detection and Analytics/ Human/Vehicle Analysis	Facial Detection and Analytics/ Human/Vehicle Analysis	-	Facial Detection and Analytics/ Human/Vehicle Analysis	-
Recorded Resolution	Up to 8K (32MP)	Up to 8K (32MP)	Up to 8K (32MP)	Up to 8K (32MP)	Up to 4K (8MP)	Up to 4K (8MP)	Up to 4K (8MP)	Up to 4K (8MP)
Video Interface	1 HDMI & 1 VGA independent output	1 HDMI & 1 VGA independent output	*1 HDMI & 1 VGA independent output*	1 HDMI & 1 VGA independent output	1 HDMI; 1 VGA	1 HDMI; 1 VGA	1 HDMI; 1 VGA	1 HDMI; 1 VGA
Hard Drive	8 SATA interface (Max 10TB for each)	8 SATA interface (Max 10TB for each)	4 SATA interface (Max 10TB for each)	4 SATA interface (Max 10TB for each)	1 SATA interface (Max 10TB for each)	1 SATA interface (Max 10TB for each)	1 SATA interface (Max 10TB for each)	1 SATA interface (Max 10TB for each)
Power Supply	100 to 240 VAC, 50 to 60 Hz	100 to 240 VAC, 50 to 60 Hz	100 to 240 VAC, 50 to 60 Hz	100 to 240 VAC, 50 to 60 Hz	DC 12 V, 1.5 A	DC 12 V, 1.5 A	DC 12 V, 1.5 A	DC 12 V, 1.5 A

Product Type	PoE NVR			
Product Image				
Product Model	VIGI NVR1016H-16MP	VIGI NVR1008H-8MP	VIGI NVR1004H-4P	VIGI NVR1104H-4P
Network Video Access Bandwidth	80 Mbps	80 Mbps	80 Mbps	80 Mbps
Network Video Input	16 channels	8 Channels	4 Channels	4 Channels
PoE Interface	16*10/100 Mbps, 802.3 af/at	8*10/100 Mbps, Max 113W, 802.3 af/at	4*10/100 Mbps, Max 53W, 802.3 af/at	4*10/100 Mbps, Max 53W, 802.3 af/at
Video Compression	H.265+/H.264+/H.265/H.264	H.265+/H.264+/H.265/H.264	H.265+/H.264+/H.265/H.264	H.265+/H.264+/H.265/H.264
Smart Analysis	-	-	-	-
Recorded Resolution	Up to 4K (8MP)	Up to 4K (8MP)	Up to 4K (8MP)	Up to 4K (8MP)
Video Interface	1 HDMI; 1 VGA	1 HDMI; 1 VGA	1 HDMI; 1 VGA	1 HDMI; 1 VGA(Built-in Speaker)
Hard Drive	1 SATA interface (Max 10TB for each)	1 SATA interface (Max 10TB for each)	1 SATA interface (Max 10TB for each)	1 SATA interface (Max 10TB for each) (HDD Quick Installation)
Power Supply	100 to 240 VAC, 50 to 60 Hz	DC 53.5 V, 2.43 A	DC 53.5 V, 1.31 A	DC 53.5 V, 1.31 A

*These products may be in development. Actual products may vary from displayed images and features.

**Feature availability dependent on country and region. Please follow local laws and regulations where applicable.



The VIGI network video decoder provides up to 8K signal decoding, suitable for large-scale monitoring solutions. Powerful decoding ability, customized splicing, and system management simplify maintenance.

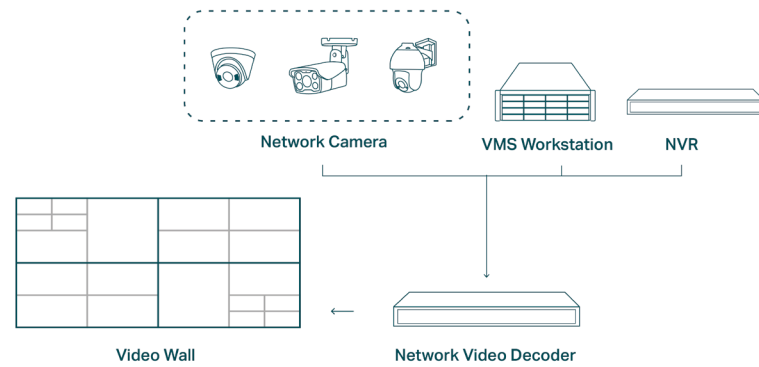

Multiple Protocols
TP-Link/ONVIF



Efficient Decoding

- H.265+/H.264+/H.265/H.264
- Up to 24x 4K cameras



Flexible Splicing

- Up to 12 HDMI
- 4K Output (3840x2160@30Hz)



Centralized Management
Compatible with VIGI Video Management System

Specifications

Product Image		
Product Model	VIGI NVD6004*	VIGI NVD6012*
Output	HDMI x 4, VGA x 4	HDMI x 12, VGA x 12
Output Resolution	4K: 3840 x 2160@30 Hz (HDMI)	4K: 3840 x 2160@30 Hz (HDMI)
Decoding Resolution	64-ch @1080P cameras simultaneously	192-ch @1080P cameras simultaneously
Split Screen	Max 36	Max 36
Video Compression	H.265+/H.264+/H.265/H.264	H.265+/H.264+/H.265/H.264
Network Interface	RJ45 interface x 1, 10/100/1000 Mbps adaptive	RJ45 interface x 1, 10/100/1000 Mbps adaptive

Key Features

Efficient Charge

Improves the conversion efficiency of light with a Grade-A solar panel, ensuring a long lifespan of at least 25 years.

25+ Year Life
Grade A Solar Panel



Durable Hardware Design

Protects the system from long-term use even in severe weather phenomena such as hurricanes.

Withstand Hurricanes (Beaufort scale 14)
IP66 Waterproof
-30°C -60°C Working Temperature



Customized Assembling

Customize your solar panel system easily with our modular hardware design. Multiple combinations of batteries and panels as well as various types of camera products are available for the VIGI integrated bracket.

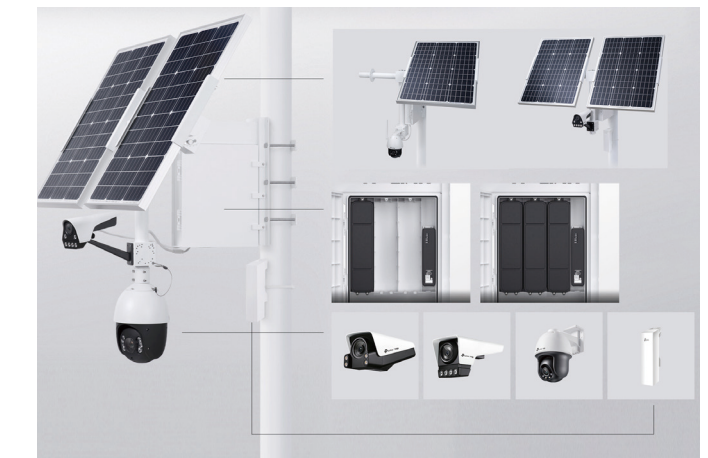

Simple Installation

Quickly install the bracket in just several minutes and build up your solar panel system.

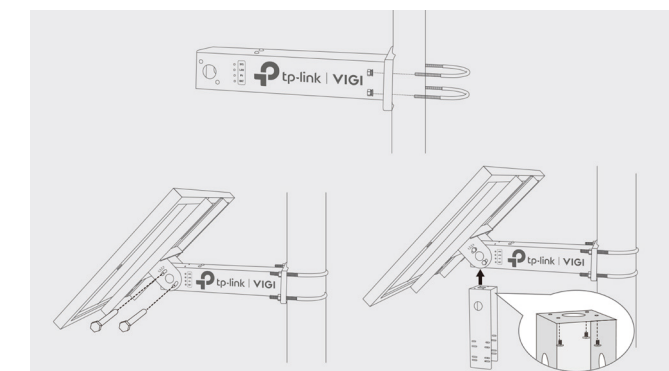

Wide Applicability

Choose a working angle flexibly to best match your situation and make use of efficiency.



*These products may be in development. Actual products may vary from displayed images and features.

Management System

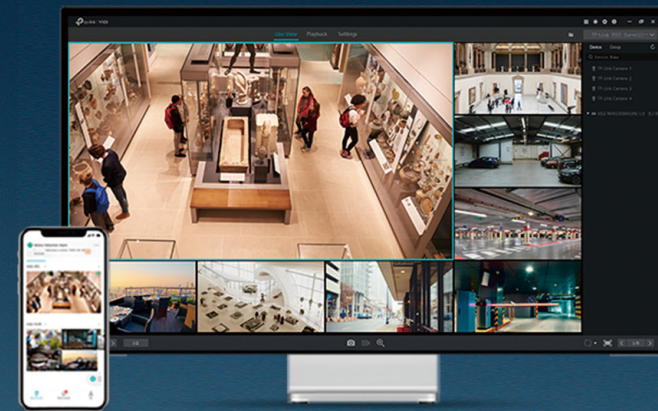

The VIGI Management System is dedicated for security management for various scenarios and applications with multiple platforms, including VMS (IP-based), VMS Workstation (Built-in VMS), and Cloud VMS (Cloud-based). We also provide the VIGI Security Manager (PC client) and VIGI app for portable security.



Small/ Standalone Solution

For portable security scenarios, users can easily manage devices via the VIGI app or control directly from the web UI.

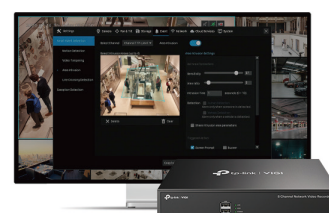

Small & Medium Business Solution

For SMB scenarios, our NVR offers both web UI and HDMI/VGA output GUI to bring a stable local management method.



Medium & Large-Scale Systems

As the device number increases, we provide a professional IP-Based or Cloud VMS system for centralized management.

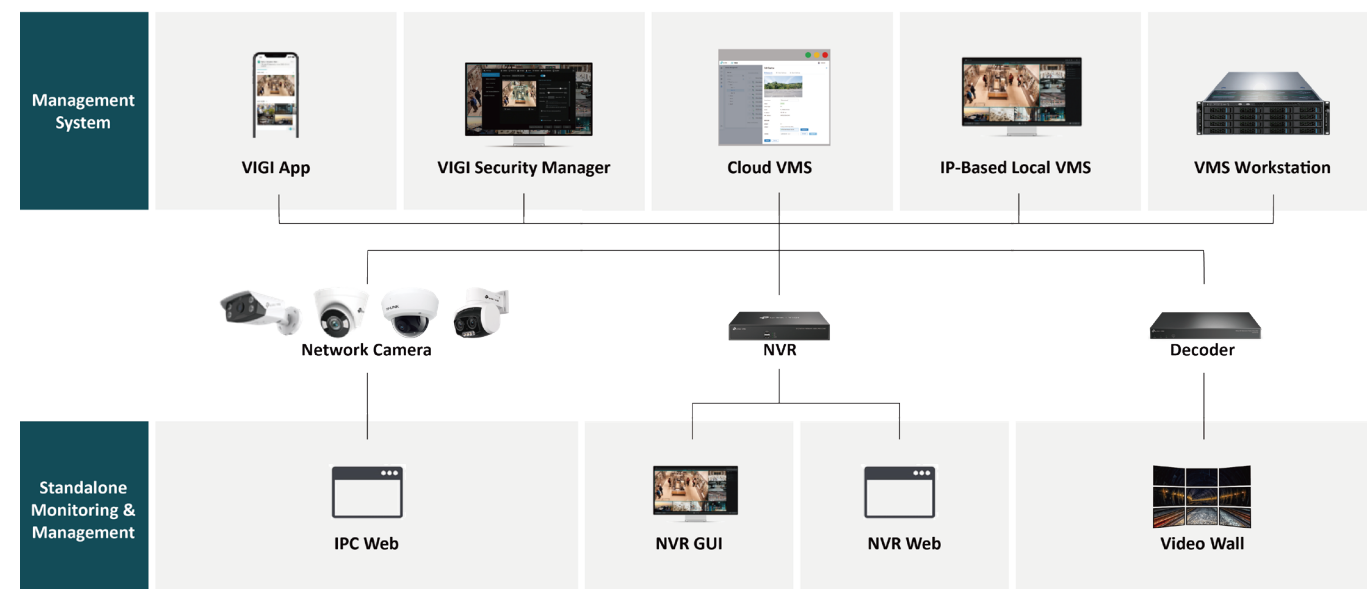

VMS

An IP-based video management software

Centralized System, Seamless Control

The VIGI Video Management System integrates network surveillance devices and provides centralized and scalable management from a single interface with powerful functions.

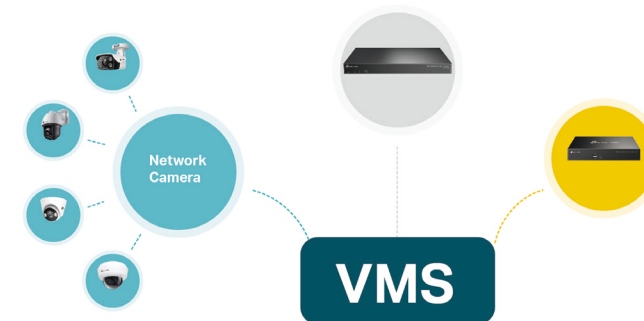

Splicing Video Wall Solution

Dedicated for large-scale surveillance systems, VMS unifies the access of multiple video sources and supports random splicing and easy management of video wall displays.



Respond Faster to Incidents

Professional real-time video to quickly realize, check, and respond to events.

- Customize your view with multiple patterns to group the cameras and focus on key areas.
- Dynamic video map display
- Highlight areas



Smart Search and Evidence Management

Efficient video management to quickly locate certain video clips and review events.

- Quickly check a time period with Smart Timeline
- Smartly search clips by motion, event, area, tag, etc.
- Bookmark, export, and lock video clips

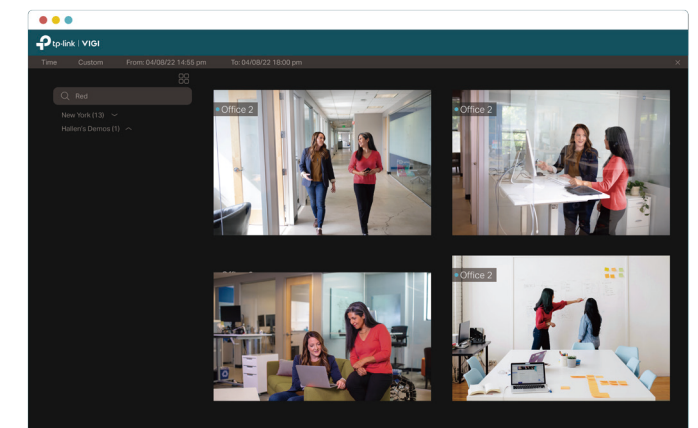

*Actual functions and interfaces may vary from displayed information.

VMS Workstation

Integrated solution with hardware and software (Built-in VMS)

VMS Workstation

- Reliable video decoding, storage, and management
- Built-in VMS
- H.265+/H.264+/H.265/H.264
- Independent internal/external networking with two RJ45 ports
- High Compatibility (ONVIF)

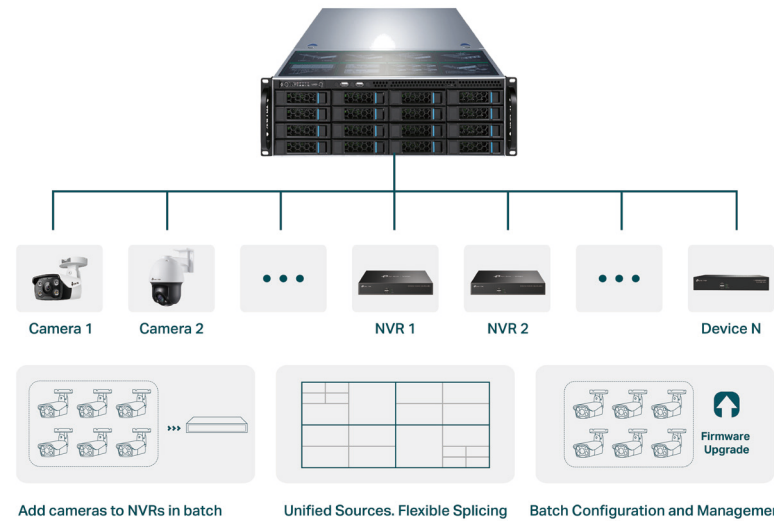

Local Deployment

Deploy VMS software integrated hardware for reliable security and easy maintenance. Manage your systems in a secure local network and store your data locally with encryptions. Local diagnostics are simple and quick.

Powerful System

Built-in VMS software meets the complex requirements of integrated devices and surveillance management, and simplifies deployment with reliable hardware and software architecture.



Specifications

Product Image		
Product Model	VMS Workstation*	VMS Workstation Pro*
Users	Max 10,000 registered / 100 logged-in users	Max 10,000 registered / 100 logged-in users
Max Input Channels	5,000	5,000
Max Output Channels	768	768
Interface	1× VGA + 1× HDMI	1× VGA + 1× HDMI
Hard Drive	-	16 SATA interface (Max. 10TB for each)
Network Interface	2× RJ45 Gigabit Ports	2× RJ45 Gigabit Ports
Feature	Area/Devices/Role Management	Area/Devices/Role Management & Storage

Cloud VMS

A cloud-based video management system

Reliable & Flexible Cloud Storage

Enjoy fast and durable storage of videos on the cloud. Check feedback at anytime and anywhere with secure and reliable access.

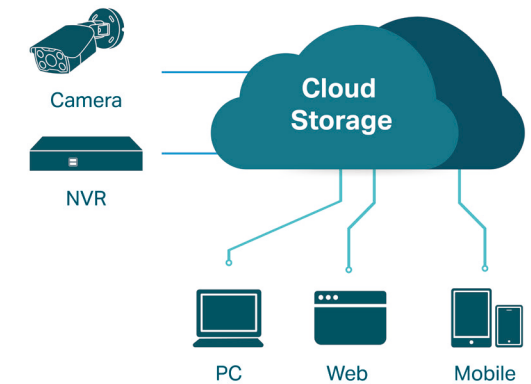

Hassle-Free Centralized Management

100% centralized management of all surveillance devices from different sites—all controlled from anywhere, anytime. Batch configuration and remote monitoring updates greatly benefit maintenance.



Assign Different Management Roles

Take advantage of multi-person management and multi-level permissions. Enjoy flexible operations and maintenance as well as reliable security that suit your situations.

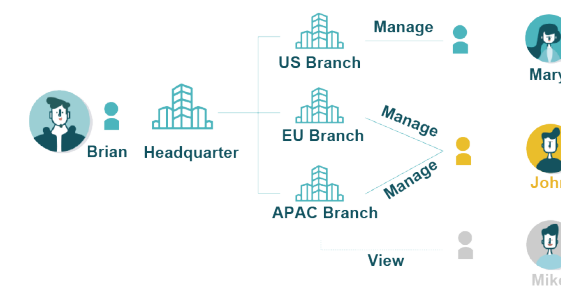

Efficient Map Monitoring

Build up your visualized surveillance system with dynamic maps and know what happens in the area. Easily locate events and follow the latest situation.

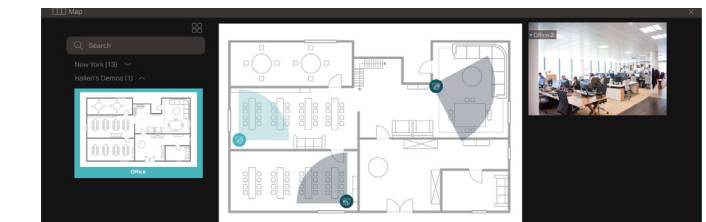

Easy to Deploy, Manage, and Extend

No need of local servers to simplify deployment and save space. Quick add your surveillance devices to the cloud in a few steps and manage centrally. Extend your surveillance network easily when your business grows.



*Actual functions and interfaces may vary from displayed information.

VIGI App

Delicate Design for Lightweight Management

Easy Setup

Security begins with just a few steps. Add devices via multiple methods and set them up with a simple and quick guide.



Remote Monitoring

Keep an eye on things even when you are on the move. Easily adjust live view options to control every corner and see more details.



Instant Alert

Get notifications as soon as an event happens, and manage your security from the palm of your hand with the VIGI app.

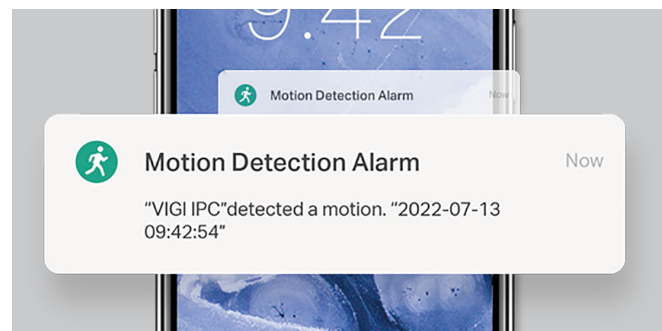

Two-way Talk

Carry two-way conversations with visitors and alert intruders without having to leave your chair.

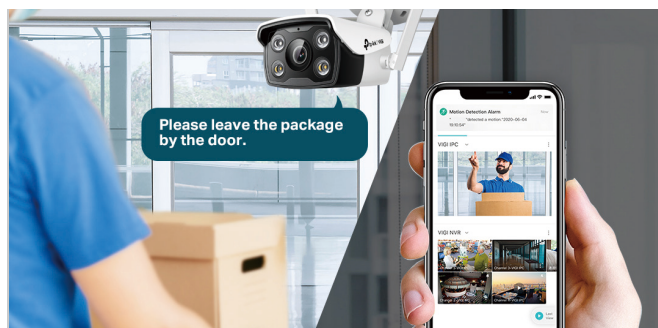

Efficient Lookup

Easily find video clips with smart search by time, types, etc. Quickly look back with no limitation of time and location.

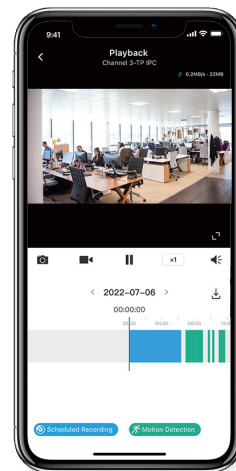

Scan the QR code to download the VIGI app.



VIGI Cloud Services

Remote Control from Anywhere

P2P Connection

Direct connections to the device with transmissions by the TP-LINK protocol greatly improve stability and data security.

Status Monitoring

Automatically detects and diagnoses device status, such as offline, failed to store, and camera tampering, to ensure your devices work normally.

Event Notifications

Get notifications as soon as an event happens via multiple platforms, no matter when they occur or where you are.

Cloud Upgrade

Simply upgrade your device to the latest and securest firmware. Save the hassle of searching for the correct firmware upgrade.

Cloud Storage

Smart

Automatically saves motion-triggered videos.

Open

No more frustrating storage limits with local storage tools.

Safe

No more video loss caused by storage card failure or camera theft.

Flexible

We offer flexible subscription plans to make sure every need is covered.

High-Level Data Security

TP-LINK strictly follows the industry's security standards to make sure that data transmissions between devices and the TP-LINK Cloud is double-encrypted from end to end.

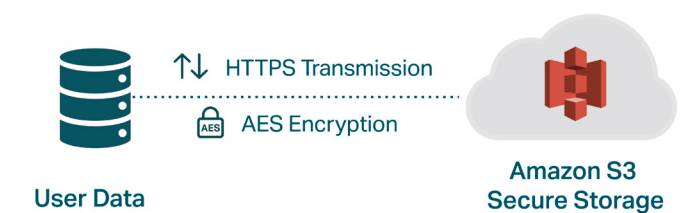

Global Service Deployment

VIGI cloud services stably cover Europe, Americas, Asia-Pacific, and other regions with multiple data centers. Enjoy global access to equipment and world-class stability and functionality.



*Actual functions may vary from displayed information.

